

Anritsu envision : ensure

Network Master™ Series

Network Master Pro MT1040A

400G (QSFP-DD) Multirate Module	MU104014A
400G (OSFP) Multirate Module	MU104015A
100G Multirate Module	MU104011A

 Network Master Pro



Network Master Pro MT1040A Overview

Redefining Transport Testing

Key I&M Merits, Including Future Expandability and High Operation Efficiency

The Network Master Pro MT1040A for 400G networks is a handheld portable instrument for evaluating the communications quality of various networks operating at speeds between 10 Mbps and 400 Gbps.

400G Ethernet uses Forward Error Correction (FEC), which requires FEC evaluation. With a built-in FEC analysis function for 400G Ethernet, the MT1040A is ideal for quality evaluation of QSFP-DD and OSFP optical modules and devices, as well as for network performance evaluation.

High-Speed Networks Supporting 5G Services

400G Ethernet networks are becoming widespread in tandem with the rollout of commercial 5G.

On the other hand, earlier 10G and 100G networks are adopting diversified interfaces, such as eCPRI, following new standards, and on-site network I&M urgently needs effective on-site test equipment facilitating efficient work to provide diverse, high-quality services at low cost using communications speeds ranging from 1 Gbps to 400 Gbps.

- One unit supports all transport-network field tests
- Easy-to-use portable semi-B5 size case with easy-to-read 9-inch touch screen
- Measurement automation-support tools for efficient one-button execution of difficult tests

Panel Overview



Network Master Pro MT1040A Mainframe Specifications

User Interfaces	
Display	9-inch active TFT display (800 × 480 pixels) and touch screen
Supported Languages	English, Chinese, Japanese, French, Russian, Spanish, Finnish, Korean, German

Service Interfaces	
USB Data Interface	MT1040A operates as host: USB 2.0 type A (2 Ports) MT1040A operates as device: USB 2.0 type Mini-B (1 port)
Ethernet Interface	Ethernet 10M/100M/1000M, RJ45 Connector: 1 port
WLAN Interface*	IEEE802.11a/b/g/n (2.4 GHz/5 GHz)
Bluetooth Interface*	Bluetooth (BT2.1+EDR/3.0/4.2 (BLE)) (File access only)

*: Available for certified countries and regions including USA, Japan and EU countries. Please visit the Anritsu web site for updated information.
The Bluetooth® mark and logos are registered trademarks of Bluetooth SIG, Inc.

Other Interfaces	
AUX Connector	For connection of optional G0325A GPS receiver
Internal Clock	Accuracy: ±4.6 ppm or less, STRATUM3 compliant
Ext. Clock Input	For connection of external clock signals: SETS (E1: 2.048 Mbps), BITS (DS1: 1.544 Mbps) or 2.048 MHz TTL signal in accordance with ITU-T G.703, 10 MHz Connector: BNC (50Ω)

Miscellaneous		
Storage Capacity	8 Gbyte	
Battery	11.25 V rechargeable and replaceable intelligent Li-ion battery × 2 Operating time: 1 hours (typ., in case of 400 GbE) Charging time: 9 hours (Max.) (2 pcs) Remaining capacity indication: %	
Mains Adapter	Input: 100 V(ac) to 240 V(ac), 50 Hz/60 Hz Output: 19 V(dc), 15.8 A (max.) Power Consumption: ≤250 W	
Dimensions and Mass	261.6 (W) × 167 (H) × 68 (D) mm (Exclude Projection, MT1040A) 261.6 (W) × 167 (H) × 134 (D) mm (Exclude Projection, MT1040A + MU104014A) 261.6 (W) × 167 (H) × 154 (D) mm (Exclude Projection, MT1040A + MU104014A + MU100020A) ≤4.7 kg (including MT1040A, MU104014A and battery) ≤5.5 kg (including MT1040A, MU104014A, MU100020A and battery)	
Environmental	Operating Temperature: 0°C to +50°C, Humidity: ≤85% RH (non-condensing) Charging Temperature: 0°C to +40°C, Humidity: ≤85% RH (non-condensing) Storage Temperature: -30°C to +60°C, Humidity: ≤90% RH (non-condensing, without battery and AC adapter) -20°C to +40°C, Humidity: ≤90% RH (non-condensing, with battery and AC adapter)	
CE	EMC	2014/30/EU, EN61326-1, EN61000-3-2
	LVD	2014/35/EU, EN61010-1
	RoHS	2011/65/EU, EN50581

400G (QSFP-DD) Multirate Module MU104014A Specifications

Test Interface																																																																																																																																														
Test Port	<p>QSFP-DD/QSFP28/QSFP+: 1 slot QSFP-DD Hardware Specification for QSFP Double Density 8X Pluggable Transceiver – Rev 4.0 compliant SFF-8436, SFF-8472, SFF-8665 compliant, IEEE 802.3 ba-2010 compliant, OIF-CEI-56G-VSR compliant</p> <p>QSFP+/QSFP28: 1 slot SFF-8436, SFF-8472, SFF-8665 compliant, IEEE 802.3ba-2010 compliant</p> <p>SFP/SFP+/SFP28: 2 slot SFF-8402, SFF-8431, SFF-8472 compliant, IEEE 802.3ae-2002, IEEE 802.3-2008, IEEE 802.3by compliant</p> <p>RJ45: 2 sockets IEEE802.3-2008 10BASE-T, 100BASE-TX, 1000BASE-T compliant Auto MDI-X 10 Mbps/100 Mbps Full/Half Duplex, 1000 Mbps Full Duplex</p>																																																																																																																																													
Bit Rate*1	<table border="1"> <thead> <tr> <th>Standard</th> <th>Bit Rate</th> <th>Interfaces</th> </tr> </thead> <tbody> <tr><td>10BASE-T</td><td>12.5 Mbit/s</td><td>RJ45</td></tr> <tr><td>100BASE-TX</td><td>125 Mbit/s</td><td>RJ45</td></tr> <tr><td>1000BASE-T</td><td>1.25 Gbit/s</td><td>RJ45</td></tr> <tr><td>10GBASE-T</td><td>10.3125 Gbit/s</td><td>RJ45 (SFP+)</td></tr> <tr><td>100BASE-X</td><td>125 Mbit/s</td><td>SFP</td></tr> <tr><td>1000BASE-X</td><td>1.25 Gbit/s</td><td>SFP</td></tr> <tr><td>10GBASE-X</td><td>10.3125 Gbit/s</td><td>SFP+</td></tr> <tr><td>25 GbE</td><td>25.781250000 Gbit/s × 1 Lane</td><td>SFP28</td></tr> <tr><td>40 GbE</td><td>10.312500000 Gbit/s × 4 Lane</td><td>QSFP+</td></tr> <tr><td>100 GbE</td><td>25.781250000 Gbit/s × 4 Lane</td><td>QSFP28</td></tr> <tr><td>400 GbE</td><td>53.125000000 Gbit/s × 8 Lane (26.5625 GBd PAM4 × 8 Lane)</td><td>QSFP-DD</td></tr> <tr><td>OTU1</td><td>2.666057143 Gbit/s</td><td>SFP</td></tr> <tr><td>OTU2</td><td>10.709225319 Gbit/s</td><td>SFP+</td></tr> <tr><td>OTU1e</td><td>11.049 107143Gbit/s</td><td>SFP+</td></tr> <tr><td>OTU2e</td><td>11.095727848 Gbit/s</td><td>SFP+</td></tr> <tr><td>OTU1f</td><td>11.270089286 Gbit/s</td><td>SFP+</td></tr> <tr><td>OTU2f</td><td>11.317642405 Gbit/s</td><td>SFP+</td></tr> <tr><td>OTU3e1</td><td>11.142743644 Gbit/s × 4 Lane</td><td>SFP+</td></tr> <tr><td>OTU3e2</td><td>11.145838894 Gbit/s × 4 Lane</td><td>SFP+</td></tr> <tr><td>OTU3</td><td>10.754603390 Gbit/s × 4 Lane</td><td>QSFP+</td></tr> <tr><td>OTU4</td><td>27.952493392 Gbit/s × 4 Lane</td><td>QSFP28</td></tr> </tbody> </table> <table border="1"> <thead> <tr> <th>Standard</th> <th>Bit Rate</th> <th>Interfaces</th> </tr> </thead> <tbody> <tr><td>STM-1/OC-3</td><td>155.52 Mbit/s</td><td>SFP</td></tr> <tr><td>STM-4/OC-12</td><td>622.08 Mbit/s</td><td>SFP</td></tr> <tr><td>STM-16/OC-48</td><td>2488.32 Mbit/s</td><td>SFP</td></tr> <tr><td>STM-64/OC-192</td><td>9953.28 Mbit/s</td><td>SFP+</td></tr> <tr><td>CPRI1</td><td>614.4 Mbit/s</td><td>SFP</td></tr> <tr><td>CPRI2</td><td>1228.8 Mbit/s</td><td>SFP</td></tr> <tr><td>CPRI3</td><td>2457.6 Mbit/s</td><td>SFP</td></tr> <tr><td>CPRI4</td><td>3072.0 Mbit/s</td><td>SFP</td></tr> <tr><td>CPRI5</td><td>4915.2 Mbit/s</td><td>SFP+</td></tr> <tr><td>CPRI6</td><td>6144.0 Mbit/s</td><td>SFP+</td></tr> <tr><td>CPRI7</td><td>9830.4 Mbit/s</td><td>SFP+</td></tr> <tr><td>CPRI8</td><td>10137.6 Mbit/s</td><td>SFP+</td></tr> <tr><td>CPRI9</td><td>12165.12 Mbit/s</td><td>SFP+</td></tr> <tr><td>CPRI10</td><td>24330.24 Mbit/s</td><td>SFP28</td></tr> <tr><td>OBSAI 1x</td><td>768 Mbit/s</td><td>SFP</td></tr> <tr><td>OBSAI 2x</td><td>1536 Mbit/s</td><td>SFP</td></tr> <tr><td>OBSAI 4x</td><td>3072 Mbit/s</td><td>SFP</td></tr> <tr><td>OBSAI 8x</td><td>6144 Mbit/s</td><td>SFP+</td></tr> <tr><td>1GFC</td><td>1.0625 Gbit/s</td><td>SFP</td></tr> <tr><td>2GFC</td><td>2.125 Gbit/s</td><td>SFP</td></tr> <tr><td>4GFC</td><td>4.25 Gbit/s</td><td>SFP</td></tr> <tr><td>8GFC</td><td>8.5 Gbit/s</td><td>SFP</td></tr> <tr><td>10GFC</td><td>10.51875 Gbit/s</td><td>SFP+</td></tr> <tr><td>16GFC</td><td>14.025 Gbit/s</td><td>SFP+</td></tr> </tbody> </table>	Standard	Bit Rate	Interfaces	10BASE-T	12.5 Mbit/s	RJ45	100BASE-TX	125 Mbit/s	RJ45	1000BASE-T	1.25 Gbit/s	RJ45	10GBASE-T	10.3125 Gbit/s	RJ45 (SFP+)	100BASE-X	125 Mbit/s	SFP	1000BASE-X	1.25 Gbit/s	SFP	10GBASE-X	10.3125 Gbit/s	SFP+	25 GbE	25.781250000 Gbit/s × 1 Lane	SFP28	40 GbE	10.312500000 Gbit/s × 4 Lane	QSFP+	100 GbE	25.781250000 Gbit/s × 4 Lane	QSFP28	400 GbE	53.125000000 Gbit/s × 8 Lane (26.5625 GBd PAM4 × 8 Lane)	QSFP-DD	OTU1	2.666057143 Gbit/s	SFP	OTU2	10.709225319 Gbit/s	SFP+	OTU1e	11.049 107143Gbit/s	SFP+	OTU2e	11.095727848 Gbit/s	SFP+	OTU1f	11.270089286 Gbit/s	SFP+	OTU2f	11.317642405 Gbit/s	SFP+	OTU3e1	11.142743644 Gbit/s × 4 Lane	SFP+	OTU3e2	11.145838894 Gbit/s × 4 Lane	SFP+	OTU3	10.754603390 Gbit/s × 4 Lane	QSFP+	OTU4	27.952493392 Gbit/s × 4 Lane	QSFP28	Standard	Bit Rate	Interfaces	STM-1/OC-3	155.52 Mbit/s	SFP	STM-4/OC-12	622.08 Mbit/s	SFP	STM-16/OC-48	2488.32 Mbit/s	SFP	STM-64/OC-192	9953.28 Mbit/s	SFP+	CPRI1	614.4 Mbit/s	SFP	CPRI2	1228.8 Mbit/s	SFP	CPRI3	2457.6 Mbit/s	SFP	CPRI4	3072.0 Mbit/s	SFP	CPRI5	4915.2 Mbit/s	SFP+	CPRI6	6144.0 Mbit/s	SFP+	CPRI7	9830.4 Mbit/s	SFP+	CPRI8	10137.6 Mbit/s	SFP+	CPRI9	12165.12 Mbit/s	SFP+	CPRI10	24330.24 Mbit/s	SFP28	OBSAI 1x	768 Mbit/s	SFP	OBSAI 2x	1536 Mbit/s	SFP	OBSAI 4x	3072 Mbit/s	SFP	OBSAI 8x	6144 Mbit/s	SFP+	1GFC	1.0625 Gbit/s	SFP	2GFC	2.125 Gbit/s	SFP	4GFC	4.25 Gbit/s	SFP	8GFC	8.5 Gbit/s	SFP	10GFC	10.51875 Gbit/s	SFP+	16GFC	14.025 Gbit/s	SFP+
Standard	Bit Rate	Interfaces																																																																																																																																												
10BASE-T	12.5 Mbit/s	RJ45																																																																																																																																												
100BASE-TX	125 Mbit/s	RJ45																																																																																																																																												
1000BASE-T	1.25 Gbit/s	RJ45																																																																																																																																												
10GBASE-T	10.3125 Gbit/s	RJ45 (SFP+)																																																																																																																																												
100BASE-X	125 Mbit/s	SFP																																																																																																																																												
1000BASE-X	1.25 Gbit/s	SFP																																																																																																																																												
10GBASE-X	10.3125 Gbit/s	SFP+																																																																																																																																												
25 GbE	25.781250000 Gbit/s × 1 Lane	SFP28																																																																																																																																												
40 GbE	10.312500000 Gbit/s × 4 Lane	QSFP+																																																																																																																																												
100 GbE	25.781250000 Gbit/s × 4 Lane	QSFP28																																																																																																																																												
400 GbE	53.125000000 Gbit/s × 8 Lane (26.5625 GBd PAM4 × 8 Lane)	QSFP-DD																																																																																																																																												
OTU1	2.666057143 Gbit/s	SFP																																																																																																																																												
OTU2	10.709225319 Gbit/s	SFP+																																																																																																																																												
OTU1e	11.049 107143Gbit/s	SFP+																																																																																																																																												
OTU2e	11.095727848 Gbit/s	SFP+																																																																																																																																												
OTU1f	11.270089286 Gbit/s	SFP+																																																																																																																																												
OTU2f	11.317642405 Gbit/s	SFP+																																																																																																																																												
OTU3e1	11.142743644 Gbit/s × 4 Lane	SFP+																																																																																																																																												
OTU3e2	11.145838894 Gbit/s × 4 Lane	SFP+																																																																																																																																												
OTU3	10.754603390 Gbit/s × 4 Lane	QSFP+																																																																																																																																												
OTU4	27.952493392 Gbit/s × 4 Lane	QSFP28																																																																																																																																												
Standard	Bit Rate	Interfaces																																																																																																																																												
STM-1/OC-3	155.52 Mbit/s	SFP																																																																																																																																												
STM-4/OC-12	622.08 Mbit/s	SFP																																																																																																																																												
STM-16/OC-48	2488.32 Mbit/s	SFP																																																																																																																																												
STM-64/OC-192	9953.28 Mbit/s	SFP+																																																																																																																																												
CPRI1	614.4 Mbit/s	SFP																																																																																																																																												
CPRI2	1228.8 Mbit/s	SFP																																																																																																																																												
CPRI3	2457.6 Mbit/s	SFP																																																																																																																																												
CPRI4	3072.0 Mbit/s	SFP																																																																																																																																												
CPRI5	4915.2 Mbit/s	SFP+																																																																																																																																												
CPRI6	6144.0 Mbit/s	SFP+																																																																																																																																												
CPRI7	9830.4 Mbit/s	SFP+																																																																																																																																												
CPRI8	10137.6 Mbit/s	SFP+																																																																																																																																												
CPRI9	12165.12 Mbit/s	SFP+																																																																																																																																												
CPRI10	24330.24 Mbit/s	SFP28																																																																																																																																												
OBSAI 1x	768 Mbit/s	SFP																																																																																																																																												
OBSAI 2x	1536 Mbit/s	SFP																																																																																																																																												
OBSAI 4x	3072 Mbit/s	SFP																																																																																																																																												
OBSAI 8x	6144 Mbit/s	SFP+																																																																																																																																												
1GFC	1.0625 Gbit/s	SFP																																																																																																																																												
2GFC	2.125 Gbit/s	SFP																																																																																																																																												
4GFC	4.25 Gbit/s	SFP																																																																																																																																												
8GFC	8.5 Gbit/s	SFP																																																																																																																																												
10GFC	10.51875 Gbit/s	SFP+																																																																																																																																												
16GFC	14.025 Gbit/s	SFP+																																																																																																																																												
Sync Clock Output (Port 1 only)	<p>Frequency Select 1/8 or 1/16 against the bit rate of the one data lane. 400 GbE: Baudrate, 100 GbE: CAUI4, 40 GbE: XLAUI, 25 GbE: 25GAUI, OTU4: OTL 4.4, OTU3/OTU3 1/OTU3e2: OTL3.4 Level: 350 mVp-p (min.), 900 mVp-p (max.) Termination: 50Ω/AC (Single ended) Connector: SMA Female</p>																																																																																																																																													

Miscellaneous		
Dimensions and Mass	261.6 (W) × 164 (H) × 52.8 (D) mm (Exclude Projection) ≤2.0 kg (without optical modules)	
Temperature and Humidity	Operating: 0°C to +40°C, ≤85% RH (non-condensing) Storage: -30°C to +60°C, ≤90% RH (non-condensing)	
CE	EMC	2014/30/EU, EN61326-1, EN61000-3-2
	LVD	2014/35/EU, EN61010-1
	RoHS	2011/65/EU, EN50581
Laser Safety*2	<p>IEC 60825-1: 2007 Class 1M QSFP28: 100GBASE-SR4 SFP28: 25GBASE-SR IEC 60825-1: 2007 Class 1 QSFP-DD: 400GBASE-LR4, 400GBASE-DR4, 400GBASE-FR4 QSFP+: 40GBASE-LR4 SFP+: 1000BASE-SX/LX/ZX SFP: 4G FC (SX), 4G FC (LX), 4G FC (EX) OC-48 LR-1/STM L-16.1, OC-48 LR-2/STM L-16.2 100 BASE-FX, 100BASE-LX FDA 21CFR1040.10 and 1040.11*3</p> <p>QSFP+: 40GBASE-SR4 QSFP28: 100GBASE-LR4 SFP28: 25GBASE-LR SFP+: 10GBASE-LR, 10GBASE-ER, 10GBASE-ZR</p>	

- *1: The frequency accuracy depends on the accuracy of the MT1040A internal clock or the external clock of MT1040A. Refer to the external interfaces in MT1040A specifications.
- *2: Safety measures for laser products
 This product complies with optical safety standards in 21CFR1040.10, 1040.11 and IEC 60825-1; the following descriptive labels are affixed to the product.
- *3: Excludes deviations caused by conformance to Laser Notice No. 50 dated June 24, 2007.



THIS PRODUCT COMPLIES WITH 21 CFR 1040.10 AND 1040.11 EXCEPT FOR DEVIATIONS PURSUANT TO LASER NOTICE NO. 50, DATED JUNE 24, 2007

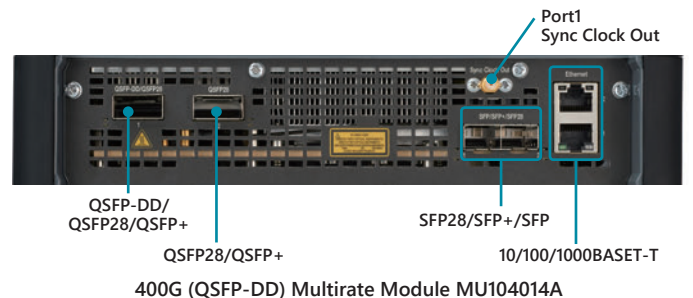

100G Multirate Module MU104011A Specifications

Test Interface						
Test Port	QSFP+/QSFP28: 2 slot SFF-8436, SFF-8472, SFF-8665 compliant, IEEE 802.3ba-2010 compliant SFP/SFP+/SFP28: 2 slot SFF-8402, SFF-8431, SFF-8472 compliant, IEEE 802.3ae-2002, IEEE 802.3-2008, IEEE 802.3by compliant RJ45: 2 sockets IEEE 802.3-2008 10BASE-T, 100BASE-TX, 1000BASE-T compliant Auto MDI-X 10 Mbps/100 Mbps Full/Half duplex, 1000 Mbps Full duplex					
Bit Rate*1	Standard	Bit Rate	Interfaces	Standard	Bit Rate	Interfaces
	10BASE-T	12.5 Mbps	RJ45	STM-1/OC-3	155.52 Mbps	SFP
	100BASE-TX	125 Mbps	RJ45	STM-4/OC-12	622.08 Mbps	SFP
	1000BASE-T	1.25 Gbps	RJ45	STM-16/OC-48	2.48832 Mbps	SFP
	10GBASE-T	10.3125 Gbit/s	RJ45 (SFP+)	STM-64/OC-192	9.95328 Mbps	SFP+
	100BASE-XX	125 Mbps	SFP	1GFC	1.0625 Gbps	SFP
	1000BASE-XX	1.25 Gbps	SFP	2GFC	2.125 Gbps	SFP
	10GBASE-XX	10.3125 Gbps	SFP+	4GFC	4.25 Gbps	SFP
	25GBASE-XX	25.78125 Gbps	SFP28	8GFC	8.5 Gbps	SFP+
	40GBASE-XX4	10.31250 Gbps × 4 Lane	QSFP+	10GFC	10.51875 Gbps	SFP+
	100GBASE-XX4	25.78125 Gbps × 4 Lane	QSFP28	16GFC	14.025 Gbps	SFP+
	OTU1	2.666057143 Gbps	SFP	CPRI1	614.4 Mbps	SFP
	OTU2	10.70922532 Gbps	SFP+	CPRI2	1228.8 Mbps	SFP
	OTU1e	11.04910714 Gbps	SFP+	CPRI3	2457.6 Mbps	SFP
	OTU2e	11.09572785 Gbps	SFP+	CPRI4	3072.0 Mbps	SFP
	OTU1f	11.27008929 Gbps	SFP+	CPRI5	4915.2 Mbps	SFP+
	OTU2f	11.31764241 Gbps	SFP+	CPRI6	6144.0 Mbps	SFP+
	OTU3	10.75460339 Gbps × 4 Lane	QSFP+	CPRI7	9830.4 Mbps	SFP+
	OTU3e1	11.14274364 Gbps × 4 Lane	QSFP+	CPRI8	10137.6 Mbps	SFP+
	OTU3e2	11.14583889 Gbps × 4 Lane	QSFP+	CPRI9	12165.12 Mbps	SFP+
	OTU4	27.95249339 Gbps × 4 Lane	QSFP28	CPRI10	24330.24 Mbps	SFP28
				OBSAI 1x	768 Mbps	SFP
				OBSAI 2x	1536 Mbit/s	SFP
				OBSAI 4x	3072 Mbps	SFP
				OBSAI 8x	6144 Mbps	SFP+
Sync Clock Output (Port 1 only)	Frequency Select 1/8 or 1/16 against the bit rate of the one data lane. 100 GbE: CAUI4, 40 GbE: XLAUI, 25 GbE: 25GAUI, OTU4: OTL 4.4, OTU3/OTU3e1/OTU3e2: OTL3.4 Level: 350 mVp-p (min.), 900 mVp-p (max.) Termination: 50Ω/AC (Single ended) Connector: SMA Female					

Miscellaneous					
Dimensions and Mass	261.6 (W) × 164 (H) × 52.8 (D) mm (Exclude Projection) ≤2.0 kg (without optical modules)				
Temperature and Humidity	Operating: 0°C to +40°C, ≤85% RH (non-condensing) Storage: -30°C to +60°C, ≤90% RH (non-condensing)				
CE	EMC	2014/30/EU, EN61326-1, EN61000-3-2			
	LVD	2014/35/EU, EN61010-1			
	RoHS	2011/65/EU, EN50581			
Laser Safety*2	IEC 60825-1: 2007 Class 1M QSFP28: 100GBASE-SR4 QSFP+: 40GBASE-SR4 SFP28: 25GBASE-SR IEC 60825-1: 2007 Class 1 QSFP28: 100GBASE-LR4 QSFP+: 40GBASE-LR4 SFP28: 25GBASE-LR SFP+: 1000BASE-SX/LX/ZX, 10GBASE-LR/ER/ZR SFP: 4G FC (SX), 4G FC (LX), 4G FC (EX), OC-48 LR-1/STM L-16.1, OC-48 LR-2/STM L-16.2, 100BASE-FX/LX FDA 21CFR1040.10 and 1040.11*3				

- *1: The frequency accuracy depends on the accuracy of the MT1040A internal clock or the external clock of MT1040A. Refer to the external interfaces in MT1040A specifications.
- *2: Safety measures for laser products
This product complies with optical safety standards in 21CFR1040.10, 1040.11 and IEC 60825-1; the following descriptive labels are affixed to the product.
- *3: Excludes deviations caused by conformance to Laser Notice No. 50 dated June 24, 2007.



THIS PRODUCT COMPLIES WITH 21 CFR 1040.10 AND 1040.11 EXCEPT FOR DEVIATIONS PURSUANT TO LASER NOTICE NO. 50, DATED JUNE 24, 2007.

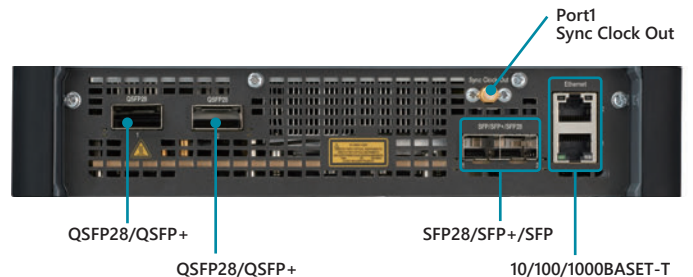

100G Multirate Module MU104011A

Ethernet Testing Specifications

Test Interface			
Model	MU104014A	MU104015A	MU104011A
Option	MU104014A-012 (Up to 25G) MU104014A-013/014 (40G) MU104014A-015/016 (100G) MU104014A-033 (400G) MU104014A-020 (TCP Throughput)	MU104015A-012 (Up to 25G) MU104015A-013 (40G) MU104015A-015 (100G) MU104015A-033 (400G) MU104015A-020 (TCP Throughput)	MU104011A-012 (Up to 25G) MU104011A-013/014 (40G) MU104011A-015/016 (100G) MU104011A-020 (TCP Throughput)
Bit Rate	10 Mbps (RJ45), 100 Mbps (RJ45/SFP), 1 Gbps (RJ45/SFP), 10 Gbps (RJ45/SFP+), 25 Gbps (SFP28), 40 Gbps (QSFP+), 100 Gbps (QSFP28), 400 Gbps (QSFP-DD)	10 Mbps (RJ45), 100 Mbps (RJ45/SFP), 1 Gbps (RJ45/SFP), 10 Gbps (RJ45/SFP+), 25 Gbps (SFP28), 40 Gbps (QSFP+), 100 Gbps (QSFP28), 400 Gbps (OSFP)	10 Mbps (RJ45), 100 Mbps (RJ45/SFP), 1 Gbps (RJ45/SFP), 10 Gbps (RJ45/SFP+), 25 Gbps (SFP28), 40 Gbps (QSFP+), 100 Gbps (QSFP28)
Test Application	RFC 2544, RFC 6349, Y.1564, BERT, Monitor/Generator, Pass-through, Reflector, Channel Stat., Ping, Traceroute, Cable Test		
Auto MDI-X	On/Off		
Frame	Ether Type II (DIX v.2), IEEE 802.3 with 802.2 (LLC1), IEEE 802.3 with SNAP		
400 GbE FEC	FEC: On Fix FEC Code: RS (544, 514, 15, 10) FEC status & counter Loss of FEC alignment, Corrected CW, Uncorrectable CW, FEC Symbol error (Per lane) FEC Error Injection Bit error per PAM4 encoded FEC (Timing: Single, Burst) FEC Symbol error (CW) Distribution Corrected Symbol Error (Graph, Table)		—
100 GbE, 25 GbE FEC	FEC enable : On/Off FEC Code: RS (528, 514, 7, 10) FEC status & counter Loss of FEC alignment, Corrected CW, Uncorrectable CW, FEC Symbol error (Per lane) FEC related Error Injection Bit error per CAUI4 lane or 25G CAUI encoded RS-FEC (Timing: Single, Burst)		

Configuration, Monitor/Generate			
Model	MU104014A	MU104015A	MU104011A
Traffic Generation	400 Gbps <ul style="list-style-type: none"> • Transmitting mode: Normal • Frame Size: Constant, Random • IP identifier: Fixed • Test Pattern: PRBS31, User 32 bit pattern • MAC Header Variable: Random • IP Header Variable: Random • Configurable IP and Ethernet source and destination addresses (supports IPv4 and IPv6 addressing) IPv4: Fixed, DHCP, DNS IPv6: Fixed, NDP 		—
	Up to 100G <ul style="list-style-type: none"> • Transmitting mode: Normal, Burst • Frame Size: Constant, Step, Random • IP identifier: Fixed, incremented • Test Pattern: PRBS9/11/15/20/23/29/31, Cross pattern • MAC Header Variable: Increment, Decrement, Random • IP Header Variable: Increment, Decrement, Random • Configurable IP and Ethernet source and destination addresses (supports IPv4 and IPv6 addressing) IPv4: Fixed, DHCP, DNS IPv6: Fixed, NDP • IGMP: Join/Leave (Support version: IGMPv1, IGMPv2, IGMPv3) • MLD: Join/Leave (Support version: MLDv1, MLDv2) 		
	Both <ul style="list-style-type: none"> • Variable line rate traffic generation, up to full line rate • Line load profile: Constant, Ramp • Traffic duration: Continuous, Programmable number of seconds or frames • Adjustable frame size: 60 bytes to 16000 bytes • Payload profiles: Data, Video, Voice • User-defined traffic mix of unicast and broadcast frames • User programmable DSCP/TOS byte • User programmable UDP/TCP address • Automatic TCP connect (user selectable) • UDP check sum: Automatic, Fixed (null); TCP check sum: Automatic • Generate pause frames, Respond to pause frames • Answer incoming ARP, Ping requests (On/Off) • Link Fault Signaling (LFS) Emulation (10 Gbps, 25 Gbps, 40 Gbps, 100 Gbps, 400 Gbps) 		

Ethernet Testing Specifications

Stacked VLAN	User-settable VLAN tags 400G: Up to 4 Up to 100G: Up to 8 Parameters per VLAN tag: <ul style="list-style-type: none"> • Ether-type 0x8100 (802.1Q), 0x88a8 (802.1ad), 0x9100 or 0x9200 • User-defined VLAN ID, CFI, VLAN priority • Up to 100G: Address increment, Decrement and Random generation supported • 400G: Address Random generation supported Only one VLAN level supported at traceroute and RFC 2544 router latency tests. Only two VLAN level supported at ping.
Multistream	Number of streams: Up to 16 streams per port can be activated
Latency Resolution	5 ns (10M/100M/1000M, 10G, 25G, 40G, 100G, 400G), 100 ns (10M/100M/1000M, 10G, 25G, 40G, 100G)
Timing Source	Internal clock, Received clock, External clock (2-MHz signal, SETS (E1: 2.048 Mbps), BITS (DS1: 1.544 Mbps)), GPS receiver (with G0325A)
Frequency Offset	±200 ppm, 0.1 ppm step
Receive Setting	<ul style="list-style-type: none"> • User-defined expected preamble length: 3 bytes to 15 bytes • User-defined IFG lower threshold: 8 bytes to 15 bytes (RJ45 port only) • User-defined Jumbo frame size upper limit: 1519 bytes to 16000 bytes
Error Generation	<ul style="list-style-type: none"> • LAN error IFG for Ethernet (RJ45 port only), FCS, Preamble, Error symbol/block, Wrong IP check sum, Fragmented IP, Wrong layer 4 check sum, PRBS bit error, BER test sequence error • PCS error 400G: 66B error 40G, 100G: Invalid block type (0x00, 0x2d, 0x33, 0x66), Invalid sync header (00, 11), Invalid alignment marker, BIP error 10G, 25G: Invalid block type (0x00), Invalid sync header (00, 11), Invalid alignment marker, BIP error • FEC error 400G: FEC Symbol error (each lane), Symbol error (CW), Invalid alignment marker 100G: FEC Symbol error (each lane) 25G: FEC Symbol error (each lane)
Alarm Generation	No link, Remote fault, Local fault (10 Gbps, 40 Gbps, 100 Gbps), PCS (10 Gbps, 40 Gbps, 100 Gbps) : High BER
PCS Skew	40 Gbps, 100 Gbps, 400 Gbps <ul style="list-style-type: none"> • Insertion <ul style="list-style-type: none"> 400 Gbps Tx lane: 0 to 8000 bits 100 Gbps Tx lane: 0 to 4224 bits 40 Gbps physical lane: 0 to 8448 bits • Detection <ul style="list-style-type: none"> Relative skew, Marker map

Result, Monitor/Generate	
Bit Rate	10 Mbps, 100 Mbps, 1 Gbps, 10 Gbps, 25 Gbps, 40 Gbps, 100 Gbps, 400 Gbps
Status	<ul style="list-style-type: none"> • Link status, Interface type, Jabber detected, Frames present, MPLS/EoMPLS/VLAN, Speed, Full or half duplex, Local clock (Electrical 1000 Mbps), LFS LF/RF (10 Gbps), Signal present, Bit rate of incoming Ethernet signal, Auto negotiation complete • Link partner abilities: Pause capable and Asymmetric pause request (not Ethernet 10 Gbps and more), Remote fault, Speed/Duplex • Indicators for Utilization, Throughput and Errored frames • Signal level indication for optical Ethernet interfaces • LFS local fault, LFS remote fault, High BER, LOA (10 Gbps, 25 Gbps, 40 Gbps, 100 Gbps, 400 Gbps) • Invalid sync header, Invalid alignment marker, BIP error, Invalid block (10 Gbps, 25 Gbps, 40 Gbps, 100 Gbps)
Resolution	User-defined resolution for statistical measurements: 1, 2, 5, 10, 15, 30 s, 1, 5, 10, 15, 30 min, 1, 2, 4, 6, 12 h Event log: Major measurement events incl. errors and alarms are logged with 1-second resolution.
Performance Statistics	• Utilization (Max./Min./Avg.), Throughput (Max./Min./Avg.), Frame rate (Max./Min./Avg.)
Frame Statistics	<ul style="list-style-type: none"> • Total frames, Total valid frames, Unicast/Multicast/Broadcast frames, Number of pause frames • Number of VLAN tagged frames, Max. number of VLAN layers detected, Last received VLAN ID, Last received VLAN priority • Number of MPLS frames and MPLS-TP frames. Max. number of MPLS layers detected. Last received MPLS Label, MPLS Priority and MPLS TTL. • Number of PBB frames. Last received B/I-tag ID and B/I-tag priority. • Total errored frames, Fragmented frames, Number of oversized and undersized (runts) frames, Number of FCS errored frames, Error symbol frames (not 10 Gbps)/Code violation frames (10 Gbps), Number of collisions (10 Mbps, 100 Mbps half duplex), Preamble violations, IFG violations (RJ45 port only), False carrier, LFS LF (local fault), LFS RF (remote fault)
Burst Statistics	• Total frames, Total valid frames, Number of burst, Total frames in bursts, Burst size (Max./Min./Avg.)
Frame Distribution Statistics	<ul style="list-style-type: none"> • Total valid/ frames, 64 to 127, 128 to 255, 256 to 511, 512 to 1023, 1024 to 1518 byte frames, Total number of jumbo frames • Frame size (Max./Min./Avg.)
Multistream Statistics	Available information per stream: <ul style="list-style-type: none"> • Frame loss count/rate, Throughput, Latency, Packet jitter, Frames and bytes received and transmitted
Transmit Statistics	Total frames, Total valid frames, Unicast/Multicast/Broadcast frames, FCS errors, Total errors 64 to 127, 128 to 255, 256 to 511, 512 to 1023, 1024 to 1518 byte frames, Total number of jumbo frames Total number of frames (Tx (own port) – Rx (selectable port))
PCS Statistics	LFS Local Fault, LFS Remote Fault, LOBL, Invalid sync header (10G-100G), BIP error (25G-100G), High SER (400G), High BER (10G-100G), Invalid Block (25G-100G), 64B/66B Code violation (400G)

Ethernet Testing Specifications

Filter	400G: Up to 4 filter conditions can be defined. Up to 100G: Up to 8 filter conditions can be defined. Each condition can be applied as filter: IP or MAC source address, IP or MAC destination address, Broadcast address, IEEE OUI value, Encapsulation type, VLAN ID and VLAN tag priority, MPLS, PBB source and destination MAC address, PBB B/I-tag, MPLS-TP source and destination MAC address, TPC/UDP source and destination port, User-defined pattern at defined offset
Adjustable Threshold	Utilization, Throughput, Errored frames, Collision rate, Unicast frames, Multicast frames, Broadcast frames, Pause frames, Fragmented frames, Undersized frames (runts), Oversized frames, FCS errored frames, IFG violations (RJ45 port only), Preamble violations, BER test pattern errors, Sequence errors, Diff.Tx-Rx, Symbol Error (400G) CW
DHCP	<ul style="list-style-type: none"> • Display source IPv4 address assigned by DHCP • Display current lease expire time • Display IPv4 addresses of primary and secondary DNS server when obtained by DHCP
NDP	• Apply and show source IPv6 address assigned by NDP

BER Test, Service Disruption Measurement													
Bit Rate	10 Mbps, 100 Mbps, 1 Gbps, 10 Gbps, 25 Gbps, 40 Gbps, 100 Gbps, 400 Gbps												
BER Test	<p>Generation and detection of test patterns, Count of errors in received test pattern, Pattern generation: Unframed (Layer 1), Framed Ethernet (MAC) header (Layer 2), Framed Ethernet (MAC) header with IP header (Layer 3) or Framed Ethernet (MAC) header, Framed with IP header and TCP/UDP header (Layer 4), User-defined header pattern (14 byte to 256 byte), Detection of sequence errors, loss of sequence synchronization, Frame loss count and frame loss seconds</p> <p>Throughput measurement results are calculated for:</p> <ul style="list-style-type: none"> • Utilization layer, Physical layer, Physical layer excluding preamble, Link layer, Network layer and Data layer • Min./Max./Avg. values <p>Performance (M.2100 type) parameters: ES, SES, ALS, UAT, AVT, EFS</p> <p>Test patterns: (Up to 100G) PRBS 9, PRBS 11, PRBS 15, PRBS 20, PRBS 23, PRBS 29, PRBS 31, HF test pattern, CRPAT, JTPAT, SPAT, 55 Hex, Fox, 32-bit user programmable (400G) PRBS 31, 32-bit user programmable</p> <p>User-defined resolution: 1, 2, 5, 10, 15, 30 s, 1, 5, 10, 15, 30 min, 1, 2, 4, 6, 12 h</p> <p>Event log: Major measurement events incl. errors and alarms are logged with 1-second resolution.</p>												
Error Generation	FCS, Preamble, Error symbol, IFG for Ethernet (RJ45 port only), Wrong IP check sum, Fragmented IP, Wrong layer 4 check sum, PRBS bit error, BER test sequence error(10M ~ 100G), Sequence skip error (400G)												
Alarm Generation	No link, Remote fault												
Service Disruption Measurement	<p>Service disruption measurement activated as part of BER test</p> <ul style="list-style-type: none"> • Disruption Type: Packet, LOS • Max./Avg. service disruption time <table border="1"> <thead> <tr> <th>Resolution</th> <th>1G/10G/25G</th> <th>40G/100G</th> <th>400G</th> </tr> </thead> <tbody> <tr> <td>Packet</td> <td>5 ns</td> <td>5 ns</td> <td>5 ns</td> </tr> <tr> <td>LOS</td> <td>100 ns</td> <td>1 ms</td> <td>1 ms</td> </tr> </tbody> </table> <ul style="list-style-type: none"> • Number of service disruptions 	Resolution	1G/10G/25G	40G/100G	400G	Packet	5 ns	5 ns	5 ns	LOS	100 ns	1 ms	1 ms
Resolution	1G/10G/25G	40G/100G	400G										
Packet	5 ns	5 ns	5 ns										
LOS	100 ns	1 ms	1 ms										

RFC 2544 Testing	
Bit Rate	10 Mbps, 100 Mbps, 1 Gbps, 10 Gbps, 25 Gbps, 40 Gbps, 100 Gbps, 400 Gbps
RFC 2544 Testing	<p>End-to-end network test mode (two MT1040A units in manual operation):</p> <ul style="list-style-type: none"> • Throughput, Frame loss, Latency or Packet jitter, Back-to-back frames (burstability) <p>End-to-end network test mode (two MT1040A units in Local-remote setup):</p> <ul style="list-style-type: none"> • Throughput, Frame loss, Back-to-back frames (burstability) <p>Router latency test mode: IP ping based latency test or packet jitter (up to 100G)</p> <ul style="list-style-type: none"> • VLAN support: 1

Service Activation Test (Y.1564)	
Bit Rate	10 Mbps, 100 Mbps, 1 Gbps, 10 Gbps, 25 Gbps, 40 Gbps, 100 Gbps
Functions	<ul style="list-style-type: none"> • Up to 8 services per port • Color-aware and non-color-aware in combinations (IP DSCP or VLAN PCP) • Test modes: One-way (uni- or bi-directional, symmetrical or asymmetrical), Round-trip • Verification against service acceptance criteria: Information rate, Frame transfer delay, Frame delay variation, Frame loss rate, Availability Optional GPS timing synchronization
Service Configuration Test	<ul style="list-style-type: none"> • Subtests for: Committed information rate, Excess information rate, Traffic policing, Committed burst size, Excess burst size • Step duration: 1 s to 60 s (user programmable) • Number of steps: 1 to 10 (user programmable) • Slope: Rising/Falling • Results: Pass/Fail indication, IR (Min./Avg./Max.), FL (Count/FLR), FTD, FDV (Min./Avg./Max./Current (during measurement))
Service Performance Test	<ul style="list-style-type: none"> • All services tested simultaneously at CIR • Duration 15 min, 2 h, 24 h, user programmable • Results: Pass/Fail indication, IR (Min./Avg./Max.), FL (Count/FLR), FTD, FDV (Min./Avg./Max./Current (during measurement)), AVAIL (%)

Ethernet Testing Specifications

RFC 6349 TCP Throughput Test	
Bit Rate	10 Mbps, 100 Mbps, 1 Gbps, 10 Gbps
Function	<p>Test Direction Setup</p> <ul style="list-style-type: none"> • Local → Remote • Remote → Local • Simultaneous in both directions <p>For RFC 6349 test sequence, user can choose to measure for:</p> <ul style="list-style-type: none"> • Path MTU • Baseline RTT • Window Scan and Throughput • Multi-Service <p>Multi-Service: DSCP or TOS can be set to each TCP connections</p> <p>Measurement results include:</p> <ul style="list-style-type: none"> • Auto-calculation of Bandwidth Delay Product (BDP) • Transmitted and Retransmitted Bytes • TCP Transfer Time Ratio • TCP Efficiency • Retransmitted Percentage • Buffer Delay Percentage <p>Supports connecting to iPerf server</p>

Ethernet Network Synchronization Test	
Bit Rate	10 Mbps, 100 Mbps, 1 Gbps, 10 Gbps, 25 Gbps
SyncE Protocol Emulation	<ul style="list-style-type: none"> • Signal generation for Quality Level (QL) specified by SyncE function • Analysis of QL indicated in received Ethernet signal with alarm at missing QL indications. • SyncE results: SSM Rx count and rate, SSM Tx count, Indicated QL statistics, SSF seconds • ESMC messages captured and exported in Wireshark format.
IEEE 1588 v2 Protocol Emulation	<ul style="list-style-type: none"> • Each port of the Ethernet interface can act as a timing master or a timing slave independently. • Supported profiles: G.8265.1, G.8275.1, G.8275.2, SMPTE 2059-2, User Defined • When acting as master in Unicast (G.8265.1) mode, one slave is accepted at a time. • Setting the profile to SMPTE 2059-2 sets IGMP/MLD join/leave. • If the slave requires 32, 64, or 128 Sync messages per second, IEEE 1588-2008 paragraph 7.7.2.1 specifying 90% confidence interval is not supported. • Configurable parameters <ul style="list-style-type: none"> Domain: 0 to 255 Step Mode: One-step, Two-step Delay Mechanism: Delay request/response, Peer delay Negotiation: On/Off (Unicast only) Clock Source: Internal or UTC locked with GPS Clock Identify Priority#1, #2, Class, Time Source, Accuracy Index: 0 to 255 Announce Interval: 1/8 to 32 s Announce Timeout: 2 to 255 s Sync Interval: 1/128 to 32 s Minimum Delay Request Interval: 1/128 to 32 s Unicast Duration: 60 s to 1,000 s • Protocol Stack <ul style="list-style-type: none"> Layer2: Ethernet, Ethernet/VLAN, Ethernet/MPLS Layer3: None, IPv4, IPv6 • PTP Protocol Analysis <ul style="list-style-type: none"> Statistics of IEEE 1588 messages and message rate. Logged IEEE 1588 events: Clock state transitions, State transition events, Faults and Changes in grand-master clock IEEE 1588 messages captured and exported in Wireshark format

IP Channel Statistics	
Bit Rate	10 Mbps, 100 Mbps, 1 Gbps, 10 Gbps
Statistics	<p>Statistics for up to 230 channels, identified by user-defined combinations of:</p> <ul style="list-style-type: none"> • IPv4, IPv6 or MAC address • VLAN ID or MPLS label • Protocol information • IP next header (protocol) • TCP/UDP ports <p>Traffic capacity:</p> <ul style="list-style-type: none"> • 10 Mbps, 100 Mbps, 1 Gbps, 10 Gbps, line speeds: 100% line load <p>Available Information per channel:</p> <ul style="list-style-type: none"> • Frame count/rate, Throughput, Byte count, MPLS frames, IP frame/packet size distribution, IP header bytes, IP fragments, TTL threshold violations, IP packet count/rate, IP bytes, IP throughput, IP header errors, TCP/UDP bytes, TCP/UDP packet count/rate, Throughput, TCP/UDP errored packets, Undersize frames, Oversize frames

Ethernet Testing Specifications

Ethernet Frame Capture	
Bit Rate	10 Mbps, 100 Mbps, 1 Gbps, 10 Gbps, 25 Gbps, 40 Gbps, 100 Gbps, 400 Gbps
Capture Buffer Size	1024 kbyte When capture buffer full: Stop or Wrap
Capture Frame Slicing	If activated capture frame is first 64 bytes or 128 bytes of each frame (ignores rest of the frame)
Timestamp Resolution	100 ns
Include Tx Frame	On/Off
Capture Trigger	Manual, On error, Field match Trigger position: Top, Middle
Error Trigger	Fragmented frames, Oversize frames, Undersized frames, Undersized and oversized frames, FCS errored frames, Any type
Trigger Field Pattern Data	Enabled when capture trigger setting is "Field match" • Offset: 0 to 15999 bytes • Length: 1 bytes to 16 bytes
Capture Data	Pcap format for display in Wireshark

Wireshark® is a registered trademark of the Wireshark Foundation.

Discovery	
Bit Rate	10 Mbps, 100 Mbps, 1 Gbps, 10 Gbps, 25 Gbps, 40 Gbps, 100 Gbps, 400 Gbps
Function	The Auto Discovery feature allows a local Network Master Pro user to discover other remote Network Master Pro units on the network to complete testing. The local user can manage multiple testers remotely without a dedicated network connection. Support IP version: IPv4
Setting	Network: Src MAC Address, Src IP Address, Network Mask, Gateway, DHCP Connection Security: Password VLAN: OFF, 1, 2 Frame Capture: On/Off

MPLS/MPLS-TP	
Bit Rate	10 Mbps, 100 Mbps, 1 Gbps, 10 Gbps, 25 Gbps, 40 Gbps, 100 Gbps
Number of MPLS Header	Up to 8 MPLS headers set by user
Parameters per MPLS Header	User-defined label, Exp and TTL fields in each MPLS header • Address increment, Decrement and Random generation An EoMPLS (Ethernet over MPLS) or PWE3 (Pseudo-wire emulation edge-to-edge) label (RFC 4448 control word) can be added. MPLS can only transport VLAN if EoMPLS activated.
Statistics	• Number of labels (Max./Min.) • Number of MPLS-TP frames • Last received MPLS-TP label/priority/TTL
OAM (MPLS-TP)	ITU-T G.8113.1 comply Supported OAM messages • ITU-T Y.1731: CCM, LBM, LBR, LTM, LTR, AIS, LCK, TST, MCC, LMM, LMR, 1DM, DMM, DMR, EXM, EXR, VSM, VSR, SLM, SLR • IEEE 802.1ag: CCM, LBM, LBR, LTM, LTR

PBB (Mac-in-Mac MiM)	
Bit Rate	10 Mbps, 100 Mbps, 1 Gbps, 10 Gbps, 25 Gbps, 40 Gbps, 100 Gbps
Programmable Field	B-tag, I-tag, MAC destination and source addresses
Result	Number of PBB frames, Last received B-tag VLAN ID, Last received B-tag priority, Last received I-tag priority, Last received I-tag service ID
OAM	Supported OAM messages • ITU-T Y.1731: CCM, LBM, LBR, LTM, LTR, AIS, LCK, TST, MCC, LMM, LMR, 1DM, DMM, DMR, EXM, EXR, VSM, VSR, SLM, SLR • IEEE 802.1ag: CCM, LBM, LBR, LTM, LTR

Ethernet Testing Specifications

Ethernet OAM	
Bit Rate	10 Mbps, 100 Mbps, 1 Gbps, 10 Gbps, 25 Gbps, 40 Gbps, 100 Gbps
OAM Standards Supported	<ul style="list-style-type: none"> ITU-T Y.1731 (Service layer OAM) IEEE 802.1ag (Connectivity layer OAM) IEEE 802.3 (formerly IEEE 802.3ah) (Access link OAM)
Messages Supported	Generates and receives following OAM messages. Supported OAM messages <ul style="list-style-type: none"> ITU-T Y.1731: CCM, LBM, LBR, LTM, LTR, AIS, LCK, TST, MCC, LMM, LMR, 1DM, DMM, DMR, EXM, EXR, VSM, VSR, SLM, SLR IEEE 802.1ag: CCM, LBM, LBR, LTM, LTR IEEE 802.3ah: Information, Variable Request, Variable Response, Loopback Control
IEEE 802.3ah Function	<ul style="list-style-type: none"> Discovery Loopback activate
Statistics	<ul style="list-style-type: none"> Number of each message generated/received

Ping Test	
Bit Rate	10 Mbps, 100 Mbps, 1 Gbps, 10 Gbps, 25 Gbps, 40 Gbps, 100 Gbps, 400 Gbps
Function	For Connectivity and Configuration check <ul style="list-style-type: none"> Round Trip Time (RTT) Supports IPv4 and IPv6 addressing Answer incoming ping requests (On/Off) VLAN Support: Off, 1, 2

Reflector	
Bit Rate	10 Mbps, 100 Mbps, 1 Gbps, 10 Gbps, 25 Gbps, 40 Gbps, 100 Gbps, 400 Gbps
Function	The following parameters are user selectable: <ul style="list-style-type: none"> Reflector MAC/IP address Swap all MAC addresses or one specific MAC address Swap IP addresses Swap port numbers on UDP/TCP frames Force ACK on TCP frames Answer incoming ARP, Ping requests

Traceroute	
Bit Rate	10 Mbps, 100 Mbps, 1 Gbps, 10 Gbps, 25 Gbps, 40 Gbps, 100 Gbps, 400 Gbps
Function	Trace IP route over IP network <ul style="list-style-type: none"> User-defined Max. number of hops (1 to 255) Information per hop: Ping time (Min./Max./Avg.), Number of ping timeouts

Cable Test	
Bit Rate	10 Mbps, 100 Mbps, 1 Gbps
Function	Identifies cable faults like short circuits, or breaks in wire pair, and displays distance from instrument to fault Support Cable: category 5/5e, 6/6a

10G WAN-PHY	
WAN Mode	10 Gbps Ethernet (normal), WAN-PHY (Mixed-frequency test pattern, Square wave pattern, PRBS31 pattern)
Terminology	SDH or SONET
Error Generation	SDH: A1A2, B1, B2, MS-REI, B3, HP-REI SONET: A1A2, B1, B2, REI-L, B3, REI-P
Alarm Generation	SDH: LOF, OOF, MS-AIS, MS-RDI, MS-TIM, AU-AIS, AU-LOP, HP-PLM, HP-UNEQ, HP-TIM, HP-RDI, LCD SONET: LOF, SEF, TIM-S, AIS-L, RDI-L, AIS-P, LOP-P, TIM-P, PLM-P, UNEQ-P, RDI-P
Error Measurement	SDH: A1A2, B1, B2, MS-REI, B3, HP-REI SONET: A1A2, B1, B2, REI-L, B3, REI-P G.826, G.828+G.829 or M.2101.1 (M.2100) error performance parameters are calculated
Alarm Detection	SDH: LOS, LOF, OOF, MS-AIS, MS-RDI, MS-TIM, AU-AIS, AU-LOP, HP-PLM, HP-UNEQ, HP-TIM, HP-RDI, LCD, LSS SONET: LOS, LOF, SEF, TIM-S, AIS-L, RDI-L, AIS-P, LOP-P, TIM-P, PLM-P, UNEQ-P, RDI-P, LCD-P, LSS
Overhead Byte Functionality	Generation of user-defined overhead bytes Capture and display of current overhead bytes

OTN Testing Specifications

Test Interface			
Model	MU104014A	MU104015A	MU104011A
Option	MU104014A-052 (Up to 10G) MU104014A-053/054 (40G) MU104014A-055/056 (100G) MU104014A-063 (ODU Multiplexing/Multi Stage)	MU104015A-052 (Up to 10G) MU104015A-053 (40G) MU104015A-055 (100G) MU104015A-063 (ODU Multiplexing/Multi Stage)	MU104011A-052 (Up to 10G) MU104011A-053/054 (40G) MU104011A-055/056 (100G) MU104011A-063 (ODU Multiplexing/Multi Stage)
Frame	OTU4, OTU3, OTU3e1, OTU3e2, OTU2, OTU2e, OTU1e, OTU2f, OTU1f, OTU1		
Test Application	BERT, RTD, APS		
Timing Source	Internal clock, Received clock, External clock (2-MHz signal, SETS (E1: 2.048 Mbps), BITS (DS1: 1.544 Mbps)), GPS receiver (with G0325A)		
Frequency Offset	±200 ppm, 0.1 ppm Step		
Scrambling	Complies with ITU-T G.709		

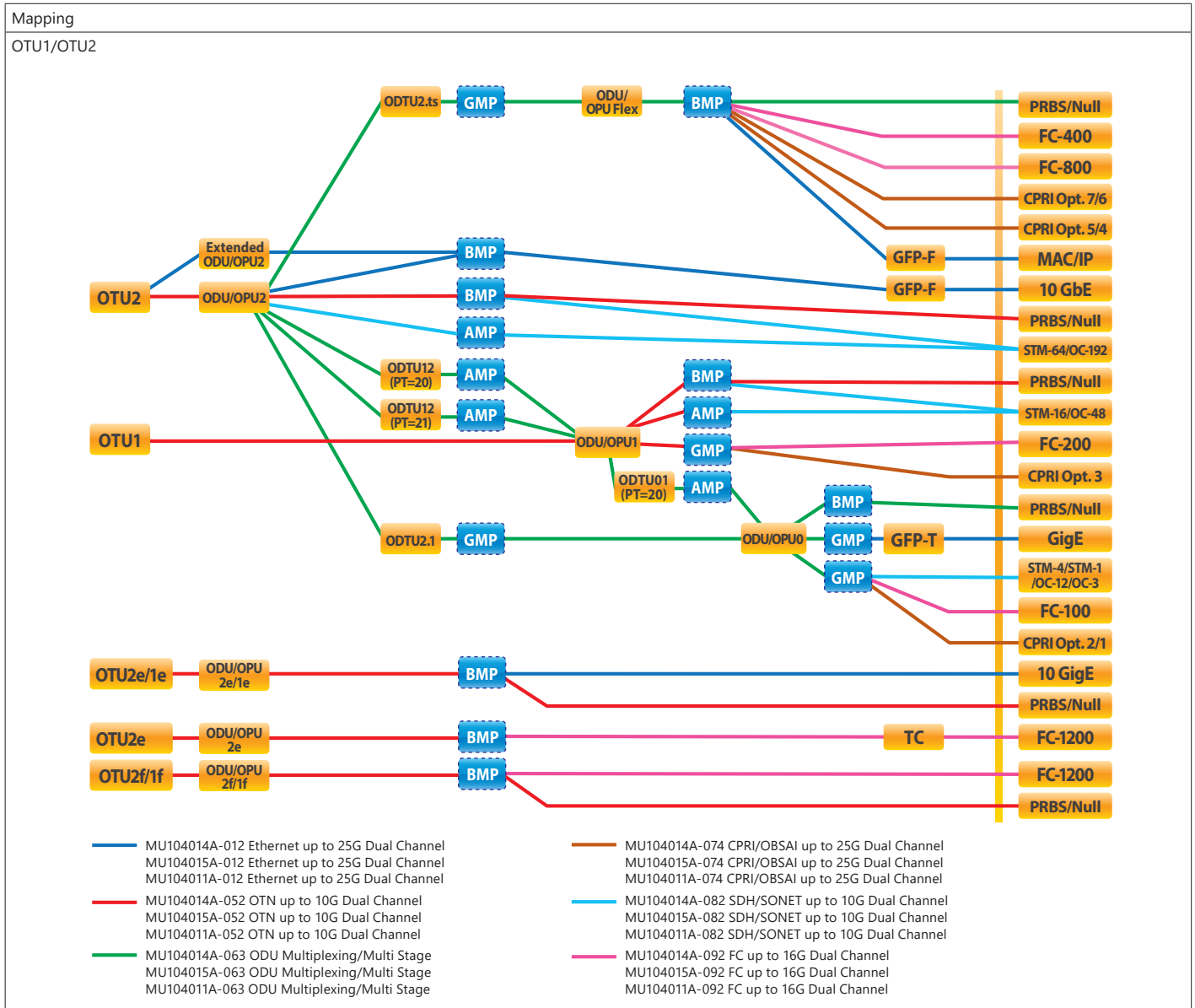

OTN Testing Specifications

OTU3

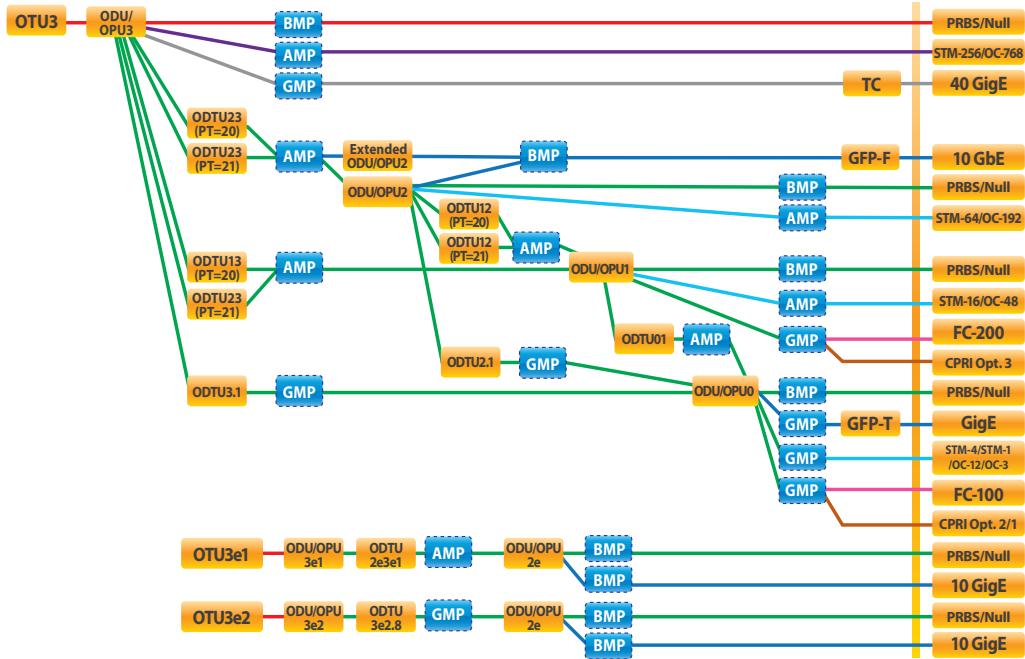

- MU104014A-012 Ethernet up to 25G Dual Channel
- MU104015A-012 Ethernet up to 25G Dual Channel
- MU104011A-012 Ethernet up to 25G Dual Channel
- MU104014A-053/054 OTN 40G Single/Dual Channel
- MU104015A-053 OTN 40G Single Channel
- MU104011A-053/054 OTN 40G Single/Dual Channel
- MU104014A-063 ODU Multiplexing/Multi Stage
- MU104015A-063 ODU Multiplexing/Multi Stage
- MU104011A-063 ODU Multiplexing/Multi Stage
- MU104014A-074 CPRI/OBSAI up to 25G Dual Channel
- MU104015A-074 CPRI/OBSAI up to 25G Dual Channel
- MU104011A-074 CPRI/OBSAI up to 25G Dual Channel
- MU104014A-082 SDH/SONET up to 10G Dual Channel
- MU104015A-082 SDH/SONET up to 10G Dual Channel
- MU104011A-082 SDH/SONET up to 10G Dual Channel
- MU104014A-092 FC up to 16G Dual Channel
- MU104015A-092 FC up to 16G Dual Channel
- MU104011A-092 FC up to 16G Dual Channel
- MU104014A-013/014 Ethernet 40G Single/Dual Channel
- MU104015A-013 Ethernet 40G Single Channel
- MU104011A-013/014 Ethernet 40G Single/Dual Channel
- MU104014A-084 STM-256/OC-768 Client Signal
- MU104015A-084 STM-256/OC-768 Client Signal
- MU104011A-084 STM-256/OC-768 Client Signal

OTU4

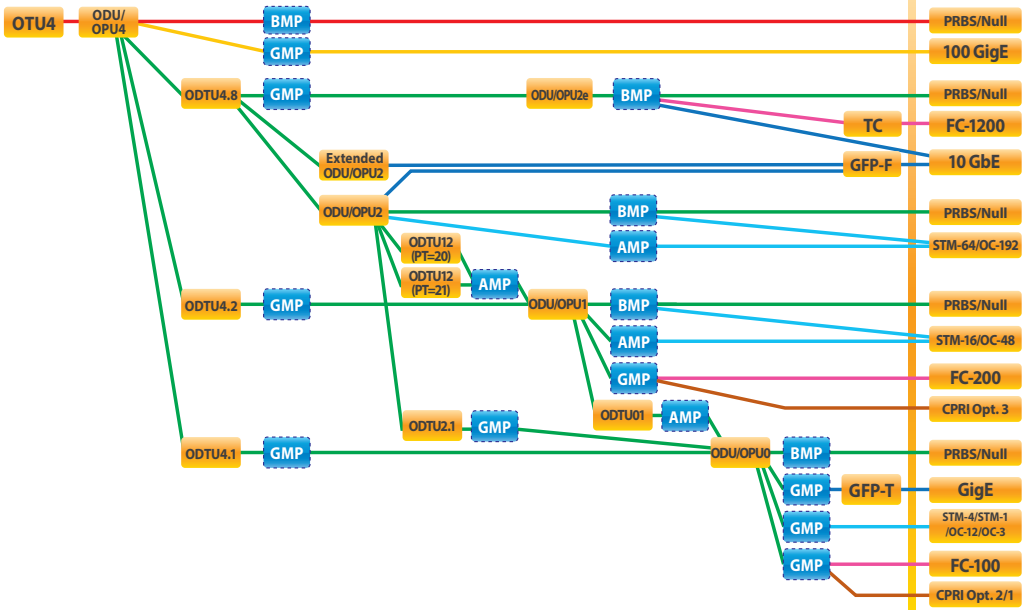

- MU104014A-012 Ethernet up to 25G Dual Channel
- MU104015A-012 Ethernet up to 25G Dual Channel
- MU104011A-012 Ethernet up to 25G Dual Channel
- MU104014A-055/056 OTN 100G Single/Dual Channel
- MU104015A-055 OTN 100G Single Channel
- MU104011A-055/056 OTN 100G Single/Dual Channel
- MU104014A-063 ODU Multiplexing/Multi Stage
- MU104015A-063 ODU Multiplexing/Multi Stage
- MU104011A-063 ODU Multiplexing/Multi Stage
- MU104014A-015/016 Ethernet 100G Single/Dual Channel
- MU104015A-015 Ethernet 100G Single Channel
- MU104011A-015/016 Ethernet 100G Single/Dual Channel
- MU104014A-074 CPRI/OBSAI up to 25G Dual Channel
- MU104015A-074 CPRI/OBSAI up to 25G Dual Channel
- MU104011A-074 CPRI/OBSAI up to 25G Dual Channel
- MU104014A-082 SDH/SONET up to 10G Dual Channel
- MU104015A-082 SDH/SONET up to 10G Dual Channel
- MU104011A-082 SDH/SONET up to 10G Dual Channel
- MU104014A-092 FC up to 16G Dual Channel
- MU104015A-092 FC up to 16G Dual Channel
- MU104011A-092 FC up to 16G Dual Channel

OTN Testing Specifications

OTN Configuration			
Model	MU104014A	MU104015A	MU104011A
OTN Alarms	<p>Detected alarms</p> <ul style="list-style-type: none"> • OTU layer: OTU-AIS, LOF, OOF, LOM, OOM, SM-TIM, SM-BIAE, SM-BDI, SM-IAE • ODU layer: LOS, ODU-AIS, ODU-OCI, ODU-LCK, PM-TIM, PM-BDI, FSF, FSD, BSF, BSD • ODU multiplexing: ODU-LOFLOM, ODU-OOF, OOM, ODU-AIS, ODU-OCI, ODU-LCK, PM-TIM, PM-BDI, MSIM • OPU layer: PLM, OPU-MSIM, Client AIS, CSF, LSS • TCM: TCMi-TIM, TCMi-BIAE, TCMi-BDI, TCMi-IAE, TCMi-LTC (i = 1 ..6) • OTL: LOF, OOF, OOR, LOR, ILA/OLA (OTU4, OTU3, OTU3e1, OTU3e2) <p>Generated alarms</p> <ul style="list-style-type: none"> • OTU layer: OTU-AIS, OTU-OOF/LOF, OOM/LOM, SM-TIM, SM-BIAE, SM-BDI, SM-IAE • ODU layer: ODU-AIS, ODU-OCI, ODU-LCK, PM-TIM, PM-BDI, FSF, FSD, BSF, BSD • ODU multiplexing: OOF/LOF, OOM/LOM, ODU-AIS, ODU-LCK, PM-TIM, PM-BDI, FSF, FSD, BSF, BSD • OPU layer: Client AIS, CSF • TCM: TCMi-TIM, TCMi-BIAE, TCMi-IAE, TCMi-BDI, TCMi-LTC (i = 1 ..6) • OTL: LOF, OOF, OOR, LOR (OTU4, OTU3, OTU3e1, OTU3e2) 		
OTN Errors	<p>Detected errors</p> <ul style="list-style-type: none"> • OTU layer: FAS, MFAS, SM-BEI, SM-BIP8, FEC-Correctable, FEC-Uncorrectable • ODU layer: PM-BIP8, PM-BEI • OPU layer: Pattern error • GMP error: CRC8 error, CRC5 error • GFP errors: cHEC corrected, cHEC uncorrectable, tHEC corrected, tHEC uncorrectable, CSF Signal, CSF Sync, Invalid GFP Frame, Superblock CRC, eHEC corrected, eHEC uncorrectable, FCS, CMF Sync, CMF Signal, SSF, PTI Mismatch, UPI Mismatch • TCM: TCMi-BEI, TCMi-BIP-8 (i = 1 to 6) • OTL: MFAS, LLM (OTU4, OTU3, OTU3e1, OTU3e2) <p>Generated errors</p> <ul style="list-style-type: none"> • OTU layer: Bit all, FAS, OTU-FAS, MFAS, SM-BIP8, SM-BEI • ODU layer: PM-BIP8, PM-BEI, ODU-FAS • TCMi-BIP8, TCMi-BEI (i = 1 to 6) • Pattern error • GMP: CRC8, CRC5, Invalid JC1, Invalid JC2, Invalid JC1&JC2 • GFP: cHEC, tHEC, Superblock CRC, eHEC, FCS, CMF Inserted Error bits are editable. • OTL: MFAS, LLM (OTU4, OTU3, OTU3e1, OTU3e2) 		
Error Performance	G.8201/M.2401 analysis of received signal based on detected errors and alarms: BBE, BBER, SES, SESR, UNAV		
Justification Analysis	<p>Count</p> <ul style="list-style-type: none"> • AMP: Positive (+1), Positive (+2), Negative (-1), Offset (ppm) • GMP: CRC8 Error, CRC5 Error, Inc, Inc > 1, Inc > 2, Inc Over, Dec, Dec > 1, Dec > 2, Dec Over, Offset (ppm), Cm (t) Max., Cm (t) Min. 		
BER Test Pattern	<p>Pattern generation and detection for bulk test patterns:</p> <ul style="list-style-type: none"> • Test patterns: PRBS 9, PRBS 11, PRBS 15, PRBS 20, PRBS 23, PRBS 29, PRBS 31, Null PRBS patterns can be inverted. • User-defined patterns (Pattern length: 2048 bits, 32 bits) 		
FEC Test	ITU-T O.182 Random error insertion		
Overhead	<p>User-editable header bytes</p> <ul style="list-style-type: none"> • OTU layer: FAS, SM, GCC0, RES • ODU layer: PM, FTFL, APS/PCC, GCC1, GCC2, RES, EXP, TCMi (i = 1 to 6) • OPU layer(s): PSI <p>Capture and display current overhead bytes</p> <ul style="list-style-type: none"> • The following signals are decoded: TTI (SM, PM, TCMi (i = 1 to 6) of high-order, FTFL, PT) 		
OTL Skew	<p>OTU4, OTU3, OTU3e1, OTU3e2</p> <ul style="list-style-type: none"> • Insertion <p>Bits: 0 to 32000 (LLD)</p> <ul style="list-style-type: none"> • Detection <p>Relative skew, Marker map</p>		
Client Signal	In addition to the MU104014A-063, mapping is supported by installing the interface option for the test target.	In addition to the MU104015A-063, mapping is supported by installing the interface option for the test target.	In addition to the MU104011A-063, mapping is supported by installing the interface option for the test target.
Through Mode	<ul style="list-style-type: none"> • Transparent mode • OH overwrite mode <p>The OTU, ODU and OPU overhead can be changed.</p> <p>The FEC encoder and decoder can be set On/Off in any mode</p>		

OTN Testing Specifications

OTN Results	
Status	Current information on: <ul style="list-style-type: none"> • Alarms and errors on monitored line • Input level indication for optical signals • Frequency • Frequency deviation
Statistics	User-defined measurement resolution: 1, 2, 5, 10, 15, 30 s, 1, 5, 10, 15, 30 min, 1, 2, 4, 6, 12 h Logged information: Alarms (s), Errors (count or count and ratio), Client Frequency, Deviation
APS	APS (Automatic Protection Switching) test and analysis <ul style="list-style-type: none"> • APS switching time is measured. A switching time exceeding the user-defined threshold is highlighted. • Start and stop triggers can be selected independently. • Trigger events can be selected from the high-order OTU and ODU, Pattern bit error, LOS (Loss of Signal). • Switching time, Switching count, Pass/Fail, Minimum, Maximum and Average can be displayed. • APS switching time measurement resolution: 0.1 ms
Round Trip Delay (Propagation Time) Measurement	Resolution: 0.1 μ s Measured Max. time: 10.0 s Interval: 0.5, 1, 2, 5, 10 s
Tributary Scan	Support rate: OTU2, OTU1e, OTU2e, OTU1f, OTU2f, OTU1 Detected alarms: OTU-AIS, LOF, OOF, LOM, OOM, SM-BIAE, SM-BDI, SM-IAE, ODU-AIS, ODU-OCI, ODU-LCK, PM-BDI, LOFLOM

Mobile xHaul Testing Specifications

Test Interface			
Model	MU104014A	MU104015A	MU104011A
Option	MU104014A-074 (CPEI/OBSAI Up to 25G) MU104014A-012 (eCPRI/RoE Up to 25G) MU104014A-013/014 (eCPRI/RoE 40G) MU104014A-015/016 (eCPRI/RoE 100G)	MU104015A-074 (CPRI/OBSAI Up to 25G) MU104015A-012 (eCPRI/RoE Up to 25G) MU104015A-013 (eCPRI/RoE 40G) MU104015A-015 (eCPRI/RoE 100G)	MU104011A-074 (CPRI/OBSAI Up to 25G) MU104011A-012 (eCPRI/RoEUp to 25G) MU104011A-013/014 (eCPRI/RoE 40G) MU104011A-015/016 (eCPRI/RoE 100G)
Bit Rate	CPRI: 614.4, 1228.8, 2457.6, 3072.0, 4915.2, 6144.0, 9830.4, 10137.6, 12165.12, 24330.24 Mbps OBSAI: 768, 1536, 3072.0, 6144.0 Mbps eCPRI/RoE (IEEE1914.3): 10M/100M/1000 Mbps, 1 Gbps, 10 Gbps, 25 Gbps, 40 Gbps, 100 Gbps		
Test Application	CPRI/OBSAI BERT, CPRI Pass Through, eCPRI/RoE BERT		

CPRI/OBSAI BER Test	
Port Mode	Off, Normal, Through (CPRI Link)
Timing Source	Internal clock, Received clock, External clock (2-MHz signal, SETS (E1: 2.048 Mbps), BITS (DS1: 1.544 Mbps)), GPS receiver (with G0325A)
Frequency Offset	±200 ppm, 0.1 ppm step
Content	Unframed, CPRI Link, OBSAI Link
Pattern	PRBS 15, PRBS 20, PRBS 23, PRBS 29, PRBS 31, User 32 bits*, Off *: Option 9 and Option 10 can be set in 8-bit units
CPRI	
Bit Rate	614.4, 1228.8, 2457.6, 3072.0, 4915.2, 6144.0, 9830.4, 10137.6, 12165.12, 24330.24 Mbps
FEC	Not supported: CPRI Option 1, 2, 3, 4, 5, 6, 7, 8 Supported: CPRI Option 9, 10
CPRI Link	Start up: Enabled, Disabled Role: Master, Slave Protocol version: 1, 2 HDLC rate: no HDLC, 240, 480, 960, 1920, 2400 kbit/s, Highest possible Ethernet: On, Off; Pointer: 20 to 63
Alarm Insertion	Signal Loss, LOS, LOF, LSS, Remote-LOS, Remote-LOF, RAI, SDI, Reset
Error Insertion	Item: LCV, SHV, K30.7, Pattern error, FEC Symbol Error Insertion timing: Manual, Rate
Alarm Detection	Signal loss, LOS, LOF, LSS
Error Detection	LCV, SHV, K30.7, Pattern error, FEC Symbol Error
FEC Error Detection	LOFA, Corr. CW, Uncorr. CW, FEC Symbol Error
Remote Status	Remote LOS, Remote LOF, RAI, SDI, Reset
Link	Rx: Protocol version, HDLC rate, Pointer P Tx: Protocol version, HDLC rate, Pointer P
Statistics	Alarms: Signal loss, LOS, LOF, LSS, Remote LOS, Remote LOF, RAI, SDI, Reset Errors: LCV, SHV, K30.7, Pattern error, FEC Symbol Error Frames count: Rx hyper frame, Rx code words, Tx hyper frame, Tx code words Delay: Delay, Average Delay, Min. Delay, Max. Delay Measurement count
OBSAI	
Bit Rate	768, 1536, 3072.0, 6144.0 Mbps
OBSAI Link	Tx: Force idle, Scramble seed, RP3 address, RP3 type Rx: Forced scrambler seed, Rx Filter, Scramble seed, RP3 address, RP3 type
Alarm Insertion	Signal Loss, LOF, No message, LSS
Error Insertion	Item: LCV, K30.7, Pattern error Insertion timing: Manual, Rate
Alarm Detection	Signal Loss, LOF, No message, LSS
Error Detection	LCV, K30.7, Pattern error
Link	Rx: Sync state
Statistics	Alarms: Signal loss, LOF, LSS Errors: LCV, K30.7, Pattern error Frames count: Tx/Rx Message Groups Delay: Delay, Average Delay, Min. Delay, Max. Delay Measurement count
CPRI/OBSAI APS	APS (Automatic Protection Switching) test and analysis <ul style="list-style-type: none"> • APS switching time is measured. A switching time exceeding the user-defined threshold is highlighted. • Trigger events (user selectable) • Alarm: Signal Loss, LOS(CPRI), LOF • Error: LCV, SHV(CPRI), Pattern error • Remote Alarm(CPRI): Remote LOS, Remote LOF, RAI, SDI, Reset • Switching time, Switching count, Pass/Fail, Minimum, Maximum and Average can be displayed. • APS switching time measurement resolution: 1 μs

Mobile xHaul Testing Specifications

CPRI Pass Through	
Port Mode	Off, Normal
Bit Rate	614.4, 1228.8, 2457.6, 3072.0, 4915.2, 6144.0, 9830.4, 10137.6 Mbps
BER Statistics	Alarms: Signal loss, LOS, LOF, LSS, Remote LOS, Remote LOF, RAI, SDI, Reset Errors: LCV, SHV, K30.7, Pattern error

eCPRI/RoE (IEEE1914.3) BER Test (Setting)	
Bit Rate	10 Mbps, 100 Mbps, 1 Gbps, 10 Gbps, 25 Gbps, 40 Gbps, 100 Gbps
Frame Length	eCPRI: 50 byte to 16000 byte RoE: 51 byte to 16000 byte
eCPRI Frame Configuration	<ul style="list-style-type: none"> • Transmitting mode: Normal, Burst • Variable line rate traffic generation, up to full line rate • Line load profile: Constant, Ramp • Traffic duration: Continuous, Programmable number of seconds or frames • Frame sizes: Constant • Protocol Stack <ul style="list-style-type: none"> Ethernet-eCPRI, Ethernet-IPv4-UDP-eCPRI, Ethernet-IPv6-UDP-eCPRI, Ethernet-VLAN-eCPRI, Ethernet-VLAN-IPv4-UDP-eCPRI, Ethernet-VLAN-IPv6-UDP-eCPRI, • eCPRI frame parameter <ul style="list-style-type: none"> • Common Header: Following the Message Type can be chosen <ul style="list-style-type: none"> IQ Data, Bit Sequence, Real-Time Control Data, Generic Data Transfer, Remote Memory Access, One-way Delay Measurement, Remote Reset, Event Indication, User Defined, None • Message Header: Change of Message Type • Payload: PRBS31 • Increment, Decrement and Random: PC_ID, SEQ_ID, RTC_ID, RESET_ID
RoE (IEEE1914.3) Frame Configuration	<ul style="list-style-type: none"> • Transmitting mode: Normal, Burst • Variable line rate traffic generation, up to full line rate • Line load profile: Constant, Ramp • Traffic duration: Continuous, Programmable number of seconds or frames • Frame sizes: Constant • Protocol Stack <ul style="list-style-type: none"> Ethernet-RoE, Ethernet-VLAN-RoE • RoE Frame setting <ul style="list-style-type: none"> • Common Header: Following the Sub Type can be chosen <ul style="list-style-type: none"> RoE Control sub type, RoE Structure-agnostic data sub type, RoE Structure-aware CPRI data sub type, RoE Slow C&M CPRI sub type, RoE Native time domain data sub type, RoE Native frequency domain data sub type, RoE Native PRACH data sub type, User Defined, None • Flow ID: Fixed, Increment, Decrement and Random • Ordering info: Fixed, Increment, Decrement and Random <ul style="list-style-type: none"> • Sub Header: Choice of the Sub Type • Payload: PRBS31
VLAN, ARP, IP/UDP Address Setting	<ul style="list-style-type: none"> • Two VLAN tags supported • Generate pause frames, Respond to pause frames • Answer incoming ARP, Ping requests (On/Off) <p>The following items can also be set only when eCPRI is selected.</p> <ul style="list-style-type: none"> • Configurable IP and Ethernet source and destination addresses (supports IPv4 and IPv6 addressing) <ul style="list-style-type: none"> IPv4: Fixed, DHCP, DNS IPv6: Fixed, NDP • Address increment, Decrement and Random generation supported • User programmable UDP port number • UDP check sum: Automatic
Timing Source	Internal clock, Received clock, External clock (2-MHz signal, SETS (E1: 2.048 Mbps), BITS (DS1: 1.544 Mbps)), GPS receiver (with G0325A)
Frequency Offset	±200 ppm, 0.1 ppm step
Receive Setting	User-defined expected preamble length: 3 bytes to 15 bytes User-defined IFG lower threshold: 8 bytes to 15 bytes (RJ45 port only) User-defined Jumbo frame size upper limit: 1519 bytes to 16000 bytes
Error Generation	IFG for Ethernet (RJ45 port only), FCS, Preamble, Error symbol/block, Wrong IP check sum, Fragmented IP, Wrong layer 4 check sum, PRBS bit error, BER test sequence error
Alarm Generation	No link, Remote fault
Link Fault Signaling (LFS) Emulation	10 Gbps, 25 Gbps, 40 Gbps, 100 Gbps

Mobile xHaul Testing Specifications

SyncE Protocol Emulation	<ul style="list-style-type: none"> • Support Interfaces: 10 Mbps (Electric), 100 Mbps (Electric/Optical), 1 Gbps (Electric/Optical), 10 Gbps (Optical), 25 Gbps (Optical) • Signal generation for Quality Level (QL) specified by SyncE function • Analysis of QL indicated in received Ethernet signal with alarm at missing QL indications. • SyncE results: SSM Rx count and rate, SSM Tx count, Indicated QL statistics, SSF seconds • ESMC messages captured and exported in Wireshark format.
IEEE 1588 v2 Protocol Emulation	<ul style="list-style-type: none"> • Support Interface: 10 Mbps (Electric), 100 Mbps (Electric/Optical), 1 Gbps (Electric/Optical), 10 Gbps (Optical), 25 Gbps (Optical) • Each port of the Ethernet interface can act as a timing master or a timing slave independently. • Supported profiles: G.8265.1, G.8275.1, G.8275.2, User Defined • When acting as master in Unicast (G.8265.1) mode, one slave is accepted at a time. • If the slave requires 32, 64, or 128 Sync messages per second, IEEE 1588-2008 paragraph 7.7.2.1 specifying 90% confidence interval is not supported. <p>Configurable parameters</p> <ul style="list-style-type: none"> Domain: 0 to 255 Step Mode: One-step, Two-step Delay Mechanism: Delay request/response, Peer delay Negotiation: On/Off (Unicast only) Clock Source: Internal or UTC locked with GPS Clock Identify Priority#1, #2, Class, Time Source, Accuracy Index: 0 to 255 Announce Interval: 1/8 to 32 s Announce Timeout: 2 to 255 s Sync Interval: 1/128 to 32 s Minimum Delay Request Interval: 1/128 to 32 s Unicast Duration: 60 s to 1,000 s <ul style="list-style-type: none"> • Protocol Stack <ul style="list-style-type: none"> Layer2: Ethernet, Ethernet/VLAN, Ethernet/MPLS Layer3: None, IPv4, IPv6 • PTP Protocol Analysis <ul style="list-style-type: none"> Statistics of IEEE 1588 messages and message rate. Logged IEEE 1588 events: Clock state transitions, State transition events, Faults and Changes in grand-master clock IEEE 1588 messages captured and exported in Wireshark format
E-OAM	<p>Standards Supported</p> <ul style="list-style-type: none"> • ITU-T Y.1731 (Service layer OAM) • IEEE 802.1ag (Connectivity layer OAM) • IEEE 802.3 (formerly IEEE 802.3ah) (Access link OAM) <p>Generates and receives following OAM messages.</p> <ul style="list-style-type: none"> • ITU-T Y.1731: CCM, LBM, LBR, LTM, LTR, AIS, LCK, TST, MCC, LMM, LMR, 1DM, DMM, DMR, EXM, EXR, VSM, VSR, SLM, SLR • IEEE 802.1ag: CCM, LBM, LBR, LTM, LTR • IEEE 802.3ah: Information, Variable request, Variable response, Loopback control
IEEE 802.3ah Function	<ul style="list-style-type: none"> • Discovery • Loopback activate

eCPRI/RoE (IEEE1914.3) BER Test (Counter, Monitor)	
Bit Rate	10 Mbps, 100 Mbps, 1 Gbps, 10 Gbps, 25 Gbps, 40 Gbps, 100 Gbps
Status	<ul style="list-style-type: none"> • Link status, Interface type, Jabber detected, Frames present, MPLS/EoMPLS/VLAN, Speed, Full or half duplex, Local clock (Ethernet 1000 Mbps), LFS LF/RF (Ethernet 10 Gbps), Signal present, Bit rate of incoming Ethernet signal, Auto negotiation complete • Link partner abilities: Pause capable and Asymmetric pause request (not Ethernet 10 Gbps and more), Remote fault, Speed/Duplex • Indicators for Utilization, Throughput and Errored frames • Signal level indication for optical Ethernet interfaces • LFS local fault, LFS remote fault, High BER, LOA (10 Gbps, 25 Gbps) • Invalid sync header, Invalid alignment marker, BIP error, Invalid block (10 Gbps, 25 Gbps)
Resolution	<ul style="list-style-type: none"> • User-defined resolution for statistical measurements: 1, 2, 5, 10, 15, 30 s, 1, 5, 10, 15, 30 min, 1, 2, 4, 6, 12 h • Event log: Major measurement events incl. errors and alarms are logged with 1-second resolution.

Mobile xHaul Testing Specifications

Performance Statistics	<ul style="list-style-type: none"> Utilization (Max./Min./Avg.), Throughput (Max./Min./Avg.), Frame rate (Max./Min./Avg.)
Frame Statistics	<ul style="list-style-type: none"> Total frames, Total valid frames, Unicast/Multicast/Broadcast frames, Number of pause frames Number of VLAN tagged frames, Max. number of VLAN layers detected, Last received VLAN ID, Last received VLAN priority Number of MPLS frames and MPLS-TP frames. Max. number of MPLS layers detected. Last received MPLS Label, MPLS Priority and MPLS TTL. Number of PBB frames. Last received B/I-tag ID and B/I-tag priority. Total errored frames, Fragmented frames, Number of oversized and undersized (runts) frames, Number of FCS errored frames, Error symbol frames (not 10 Gbps)/Code violation frames (10 Gbps), Number of collisions (10 Mbps, 100 Mbps half duplex), Preamble violations, IFG violations (RJ45 port only), False carrier, LFS LF (local fault), LFS RF (remote fault)
Burst Statistics	<ul style="list-style-type: none"> Total frames, Total valid frames, Number of burst, Total frames in bursts, Burst size (Max./Min./Avg.)
Frame Distribution Statistics	<ul style="list-style-type: none"> Total valid/ frames, 64 to 127, 128 to 255, 256 to 511, 512 to 1023, 1024 to 1518 byte frames, Total number of jumbo frames Frame size (Max./Min./Avg.)
Adjustable Threshold	Utilization, Throughput, Errored frames, Collision rate, Unicast frames, Multicast frames, Broadcast frames, Pause frames, Fragmented frames, Undersized frames (runts), Oversized frames, FCS errored frames, IFG violations (RJ45 port only), Preamble violations, BER test pattern errors, Sequence errors, Diff.Tx-Rx
BER Test	<p>Generation and detection of test patterns, Count of errors in received test pattern, Detection of sequence errors, loss of sequence synchronization, Frame loss count and frame loss seconds</p> <p>Throughput measurement results are calculated for:</p> <ul style="list-style-type: none"> Utilization layer, Physical layer, Physical layer excluding preamble, Link layer, Network layer and Data layer Min./Max./Avg. values <p>Performance (M.2100 type) parameters: ES, SES, ALS, UAT, AVT, EFS</p> <p>Test patterns: PRBS31</p> <p>User-defined resolution: 1, 2, 5, 10, 15, 30 s, 1, 5, 10, 15, 30 min, 1, 2, 4, 6, 12 h</p> <p>Event log: Major measurement events incl. errors and alarms are logged with 1-second resolution.</p>

eCPRI/RoE (IEEE1914.3) BER Test (Frame Capture)	
Bit Rate	10 Mbps, 100 Mbps, 1 Gbps, 10 Gbps, 25 Gbps, 40 Gbps, 100 Gbps
Capture Buffer Size	1024 kbyte When capture buffer full: Stop or Wrap
Capture Frame Slicing	If activated capture frame is first 64 bytes or 128 bytes of each frame (ignores rest of the frame)
Timestamp Resolution	100 ns
Include Tx Frame	On/Off
Capture Trigger	Manual, On error, Field match Trigger position: Top, Middle
Error Trigger	Fragmented frames, Oversize frames, Undersized frames, Undersized and oversized frames, FCS errored frames, Any type
Trigger Field Pattern Data	Enabled when capture trigger setting is Field match <ul style="list-style-type: none"> Offset: 0 to 15999 bytes Length: 1 bytes to 16 bytes
Capture Data	Pcap format for display in Wireshark

Fibre Channel Testing Specifications

Test Interface			
Model	MU104014A	MU104015A	MU104011A
Option	MU104014A-092 (Up to 16G)	MU104015A-092 (Up to 16G)	MU104011A-092 (Up to 16G)
Bit Rate	1.0625 Gbps (FC-100/1GFC), 2.125 Gbps (FC-200/2GFC), 4.25 Gbps (FC-400/4GFC), 8.5 Gbps (FC-800/8GFC), 10.52 Gbps (FC-1200/10GFC), 14.025 Gbps (FC-1600/16GFC)		
Test Application	FC-Performance Test, FC-BERT, FC-Reflector		

FC-BERT	
Port mode	Off, 1GFC, 2GFC, 4GFC, 8GFC, 10GFC, 16GFC
Timing source	Internal clock, Received clock, External clock (2-MHz signal, SETS (E1: 2.048 Mbps), BITS (DS1: 1.544 Mbps)), GPS receiver (with G0325A)
Topology	Point-to-point, Fabric, E-Port
Flow Control	Credit based transmitter: On/Off Buffer-to-buffer credit configuration: 1 to 65535, Buffer-to-buffer credit and R_RDY counters, R_RDY injection
Source ID	Port WWN: User define or Default ID: 000000 to FFFFFFFF
Destination ID	Port WWN: User define or Default ID: 000000 to FFFFFFFF
Traffic Generation	<ul style="list-style-type: none"> 1GFC (with SOF and EOF frame delimiters and 2GFC frames), Class-3 service frames Traffic shaping: Constant, Ramp, Burst, 2GFC frame header configuration Frame length configuration: 3240 bytes (max.)
BER test	<ul style="list-style-type: none"> Test modes: Unframed BER test, Layer 1 BER test, Layer 2 BER test Test patterns: PRBS 9, PRBS 11, PRBS 15, PRBS 20, PRBS 23, PRBS 29, PRBS 31, HF test pattern, CSPAT, CJPAT, CRPAT, JTPAT, SPAT, 55 Hex, Fox, 32-bit user programmable, ZERO Error injection: Bit, CRC, Symbol Results: Pattern loss seconds, Traffic loss seconds, Bit error count, BER
Measurement	<ul style="list-style-type: none"> Alarm detection: LOS, Link down, Pattern loss Service disruption measurement: Average/Max service disruption, Number of service disruptions Traffic statistics: Bandwidth utilization, Data rate, Frame count, Byte count, Frame size distribution, Buffer-to-buffer credit count, R_RDY count, Frame loss count, Round trip delay, Packet jitter, Bit errors, CRC errors, Symbol errors, LR, LRR, NOS, OLS

FC-Reflector	
Port mode	Off, 1GFC, 2GFC, 4GFC, 8GFC, 10GFC, 16GFC
Timing Source	Internal clock, Received clock, External clock (2-MHz signal, SETS (E1: 2.048 Mbps), BITS (DS1: 1.544 Mbps)), GPS receiver (with G0325A)
Topology	Point-to-point, Fabric, E-Port
Flow Control	Credit based transmitter: On/Off Buffer-to-buffer credit configuration: 1 to 65535, Buffer-to-buffer credit and R_RDY counters, R_RDY injection
Source ID	Port WWN: User define or Default
Frame Setup	Framing: SOF: Data: EOF or SOF: Header: Data: CRC:EOF

FC-Performance Test	
Port mode	Off, 1GFC, 2GFC, 4GFC, 8GFC, 10GFC, 16GFC
Timing source	Internal clock, Received clock, External clock (2-MHz signal, SETS (E1: 2.048 Mbps), BITS (DS1: 1.544 Mbps)), GPS receiver (with G0325A)
Topology	Point-to-point, Fabric, E-Port
Flow Control	Credit based transmitter: On/Off Buffer-to-buffer credit configuration: 1 to 65535, Buffer-to-buffer credit and R_RDY counters, R_RDY injection
Source ID	Port WWN: User define or Default ID: 000000 to FFFFFFFF
Destination ID	Port WWN: User define or Default ID: 000000 to FFFFFFFF
Test Configuration	Test Mode: Port-to-Port Test, Loopback Test Test Items: Throughput, Traffic Profile, Latency, Burst, Credit

SDH/SONET Testing Specifications

Test Interface			
Model	MU104014A	MU104015A	MU104011A
Option	MU104014A-082 (Up to 10G)	MU104015A-082 (Up to 10G)	DMU104011A-082 (Up to 10G)
Bit Rate	Optical (SFP/SFP+): STM-1/OC-3, STM-4/OC-12, STM-16/OC-48, STM-64/OC-192		
Test Application	BERT, RTD, APS		

SDH/SONET Configuration	
Framing	SDH: Complies with ITU-T G.707, SONET: Complies with Telcordia GR-253
Transmitter Clock	Internal clock, Received clock, External clock (2-MHz signal, SETS (E1: 2.048 Mbps), BITS (DS1: 1.544 Mbps)), GPS receiver (with G0325A)
Frequency Offset	±200 ppm, 0.1 ppm step
TCM Frame Format	ITU-T G.783, G.707 Annex D (TCM option 2) and Annex E, POH bytes: N1 (VC-4, VC-3), Z5 (STS-3c, STS-1), N2 (VC-12, VC-11), Z6 (VT-2, VT-1.5), TCM Access Point Identifier (Apid): 15 bytes ASCII sequence, CRC-7
Scrambling	SDH: ITU-T G.707 compliant, SONET: Telcordia GR-253 compliant

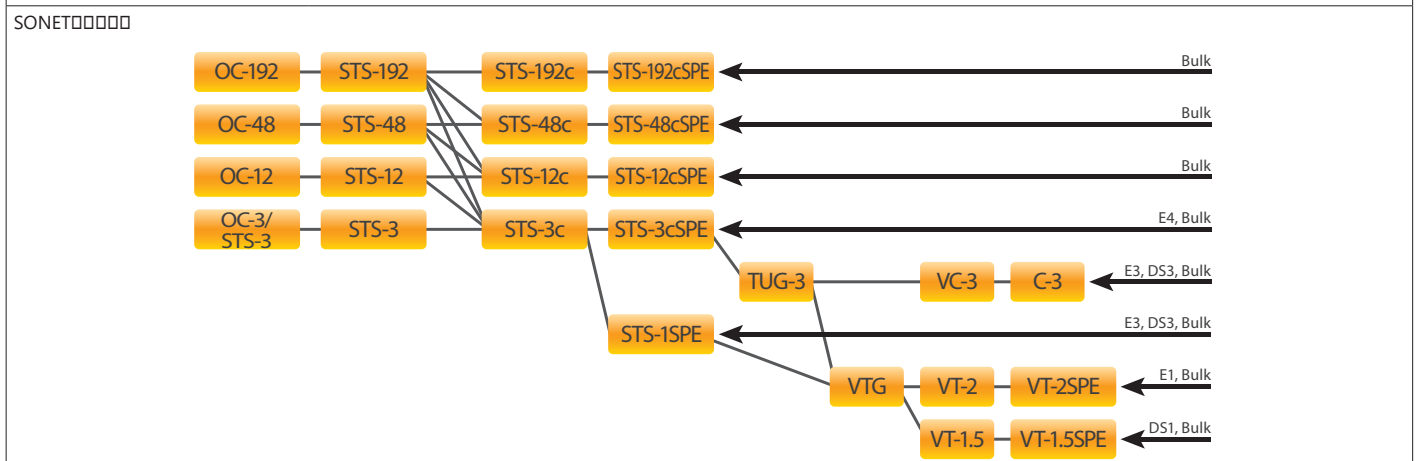
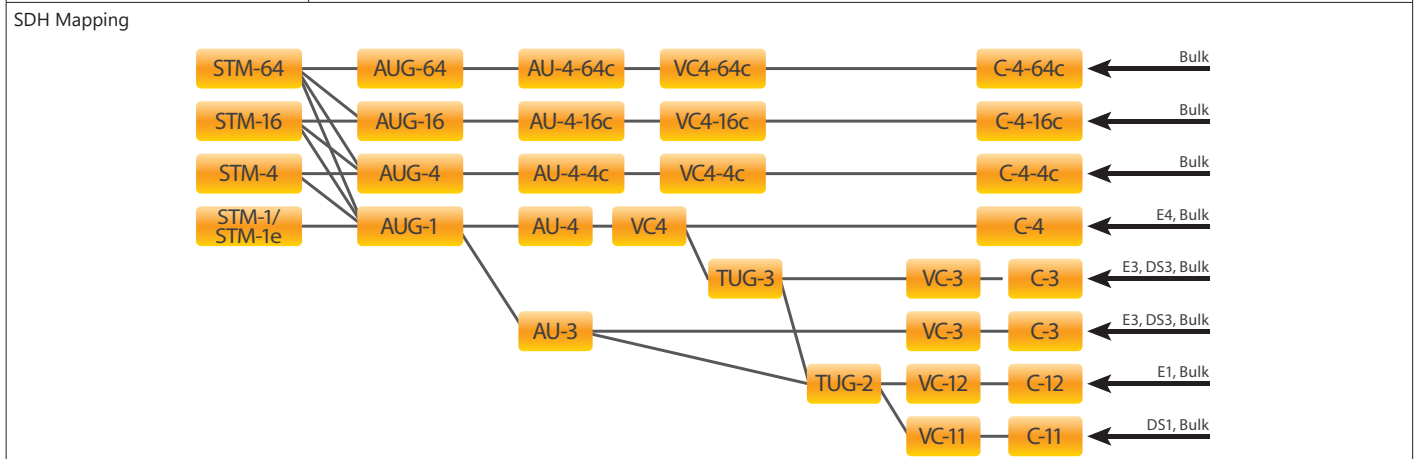

SDH/SONET Testing Specifications

SDH/SONET Testing	
Alarms	<p>Detected and generated alarms</p> <ul style="list-style-type: none"> SDH: LOS, LOF, OOF, MS-AIS, MS-RDI, AU-AIS, AU-LOP, HP-PLM, HP-UNEQ, HP-TIM, HP-RDI, TU-LOM, TU-AIS, TU-LOP, LP-PLM, LP-UNEQ, LP-TIM, LP-RDI, LSS SONET: LOS, LOF, OOF, AIS-L, RDI-L, AIS-P, LOP-P, TIM-P, PLM-P, UNEQ-P, RDI-P, LOM-V, AIS-V, LOP-V, PLM-V, UNEQ-V, RDI-V, TIM-V, LSS TCM: TC-LTC, TC-TIM, TC-UNEQ, TC-AIS, TC-RDI, TC-ODI <p>Inserted alarms</p> <ul style="list-style-type: none"> Permanent Alternate: 1 to 8000 consecutive alarm frames, 1 to 8000 consecutive normal frames
Errors	<p>Detected and generated errors</p> <ul style="list-style-type: none"> SDH: A1/A2, B1, B2, MS-REI, B3, HP-REI, V5/B3, LP-REI, Pattern error, ERR trans SONET: A1/A2, B1, B2, REI-L, B3, REI-P, V5/B3, REI-V, Pattern error, ERR trans TCM: TC-IEC, TC-BIP2, TC-REI, TC-OEI <p>Error insertion</p> <ul style="list-style-type: none"> Manual: 1 to 8000 consecutive errors (excluding Pattern error) 1 to 4000 consecutive errors (for Pattern error) Continuous: 10^{-3}, 10^{-4}, 10^{-5}, 10^{-6}, 10^{-7}, 10^{-8}, 10^{-9}, 10^{-10} (The available highest rate varies depending on the error item.) Alternate: 1 to 8000 consecutive error frames, 1 to 8000 consecutive normal frames (excluding Pattern error and ERR trans) 1 to 4000 consecutive error bits, 100 to 4000 consecutive normal bits (for Pattern error)
BER Test Pattern	<p>Pattern generation and detection for O.181 bulk test pattern</p> <ul style="list-style-type: none"> Test patterns supported: PRBS 9, PRBS 11, PRBS 15, PRBS 20, PRBS 23, PRBS 29, PRBS 31 <p>PRBS patterns can be inverted.</p> <p>All 0 s, All 1 s, Alternating 1: 1, Alternating 1: 3, Alternating 1: 7, 2 in 8</p> <p>User-defined patterns (Pattern length: up to 2048, Length step: 8-bit)</p>
Pointer	<ul style="list-style-type: none"> Support pointer events monitoring and generation Pointer test sequences: None, Single alternating, Regular + Double, Regular + Missing, Double alternating Display pointer value of receiver side Graphical display of pointer movements
Overhead	<ul style="list-style-type: none"> Generation of section/transport and path overhead bytes Display of current section/transport and path overhead bytes <p>All overhead can be decoded, including decoded J0, J1, J2 byte.</p>
Through Mode	<ul style="list-style-type: none"> Transparent mode OH overwrite mode: Can be changed SOH (SDH), TOH (SONET)

SDH and SONET Results	
Status	<p>Current information on</p> <ul style="list-style-type: none"> Alarms and errors on monitored line Input level indication for optical signals Input level indication for electrical signals Actual bit rate Frequency deviation
Statistics	<p>User-defined measurement resolution: 1, 2, 5, 10, 15, 30 s, 1, 5, 10, 15, 30 min, 1, 2, 4, 6, 12 h</p> <p>Logged information: Alarms (seconds and ratio), Errors (count or count and ratio), Pointer operations</p> <p>Event log: Major measurement events incl. errors, alarms and pointer operations are logged with 1-second resolution.</p>
Error Performance	G.826/G.828/G.829/M.2100 analysis of received signal based on detected errors and alarms: ES, SES, BBE (not M.2100), UNAV
APS	<p>APS (Automatic Protection Switching) test and analysis</p> <ul style="list-style-type: none"> APS switching time is measured. A switching time exceeding the user-defined threshold is highlighted. <ul style="list-style-type: none"> Trigger events (user selectable): <ul style="list-style-type: none"> SDH: SDH alarms and errors, pattern bit error, APS switchover SONET: SONET alarms and errors, pattern bit error, APS switchover Number of switchovers indicated by APS protocol K1/K2 bytes set and displayed <p>Resolution of APS switching time measurement, SDH</p> <ul style="list-style-type: none"> SDH events excluding VC-12 and VC-11 events, LOS (Loss of Signal): 1 μs VC-12 and VC-11 events: 0.5 ms <p>Resolution of APS switching time measurement, SONET</p> <ul style="list-style-type: none"> SONET events excluding VT-1.5 and VT-2 events, LOS (Loss of Signal): 1 μs VT-1.5 and VT-2 events: 0.5 ms
Round Trip Delay (Propagation Time) Measurement	<p>Resolution: 0.1 μs</p> <p>Measured Max. time: 10.0 s</p> <p>Interval: 0.5, 1, 2, 5, 10 s</p>

Device Testing Specification

Device Test			
Model	MU104014A	MU104015A	MU104011A
Options	MU104014A-012 (Up to 25 GbE) MU104014A-013/014 (40 GbE) MU104014A-015/016 (100 GbE) MU104014A-033 (400 GbE) MU104014A-053/054 (40G OTN) MU104014A-055/056 (100G OTN)	MU104015A-012 (Up to 25 GbE) MU104015A-013 (40 GbE) MU104015A-015 (100 GbE) MU104015A-033 (400 GbE) MU104015A-053 (40G OTN) MU104055A-055 (100G OTN)	MU104011A-012 (Up to 25 GbE) MU104011A-013/014 (40 GbE) MU104011A-015/016 (100 GbE) MU104011A-053/054 (40G OTN) MU104011A-055/056 (100G OTN)
Interface Type	QSFP+, SFP28, QSFP28, QSFP-DD	QSFP+, SFP28, QSFP28, OSFP	QSFP+, SFP28, QSFP28
Bit Rate	25.78 Gbps (25GigE), 41.25 Gbps (40 GigE), 103.12 Gbps (100 GigE), 43.01 Gbps (OTU3), 44.57 Gbps (OTU3e1), 44.58 Gbps (OTU3e2), 111.80 Gbps (OTU4), 413.0 Gbps (400 GbE)		
Lane Select	1 Lane (SFP28), 4 Lane (QSFP+, QSFP28*), 8 Lane (PAM4) (QSFP-DD, OSFP), 16 Lane (NRZ) (QSFP-DD, OSFP), 20 Lane (QSFP28)		
Timing Source	Internal clock, Received clock, External clock (2-MHz signal, SETS (E1: 2.048 Mbps), BITS (DS1: 1.544 Mbps)), GPS receiver (with G0325A)		
Frequency Offset	±200 ppm, 0.1 ppm step		
Test Pattern	PAM4: PRBS13Q/PRBS31Q, Logic Inverted NRZ: PRBS 9, PRBS 15, PRBS 23, PRBS 31, Logic Inverted		
Error Insertion	Item: Bit error Insertion timing: Single		
Monitor	Signal level: dBm Frequency: Hz, ppm LOS, LSS, CDR lock, Bit error		
Measurement	Bit error, Frequency		

*: The QSFP-DD, and QSFP28 can select test patterns for each lane.

Optical Transceivers Interface List

MUJ04014A	MUJ04015A	MUJ04011A	Model/ Order No.	Name	Form Factor	100M Ethernet	156M STM-1	614M CPRI	622M STM-4	768M OBSAI	1GFC	1.23G CPRI	1.25G Ethernet	1.54G OBSAI	2GFC	2.46G CPRI	2.488G STM-16	2.67G OTU1	3.07G CPRI OBSAI	4GFC	4.92G CPRI	6.14G CPRI OBSAI	8GFC	9.83G CPRI	9.95G STM-64	10.1G CPRI	10.3G Ethernet	10GFC	10.7G OTU2	11.05G OTU1e	11.09G OTU2e	11.27G OTU1f	11.3G OTU2f	16GFC	25G Ethernet	40G Ethernet	40G OTN	100G Ethernet	100G OTN	400G Ethernet								
✓	✓	✓	G0332A	100M FX 1310 nm MM SFP	SFP	1310 nm, MM, 2 km																																										
✓	✓	✓	G0319A	Up to 2.7G 1310 nm 15 km SFP	SFP		1310 nm, SM, 15 km																																									
✓	✓	✓	G0320A	Up to 2.7G 1310 nm 40 km SFP	SFP		1310 nm, SM, 40 km																																									
✓	✓	✓	G0321A	Up to 2.7G 1550 nm 80 km SFP	SFP		1550 nm, SM, 80 km																																									
✓	✓	✓	G0328A	1G/2G/4G FC 850 nm SFP	SFP						850 nm, MM, 0.5 km																																					
✓	✓	✓	G0322A	1G/2G/4G FC 1310 nm SFP	SFP						1310 nm, SM, 10 km																																					
✓	✓	✓	G0323A	1G/2G/4G FC 1550 nm SFP	SFP						1550 nm, SM, 40 km																																					
✓	✓	✓	G0315A	10G LR/LW 1310 nm SFP+	SFP+																																											
✓	✓	✓	G0316A	10G ER/EW 1550 nm 40 km SFP+	SFP+																																											
✓	✓	✓	G0318A	10G ZR/ZW 1550 nm 80 km SFP+	SFP+																																											
✓	✓	✓	G0329A	10G LR 1310 nm SFP+	SFP+							1310 nm, SM, 10 km																																				
✓	✓	✓	G0356A	8G FC/10G SR 850 nm SFP+	SFP+																			850 nm, MM, 0.3 km																								
✓	✓	✓	G0386A	16GFC SR 850 nm SFP+	SFP+																																											
✓	✓	✓	G0387A	16GFC LR 1310 nm SFP+	SFP+																																											
✓	✓	✓	G0388A	25G SR 850 nm SFP28	SFP28																																											
✓	✓	✓	G0389A	25G LR 1310 nm SFP28	SFP28																																											
✓	✓	✓	G0359A	40G SR4 850 nm QSFP+	QSFP+																																											
✓	✓	✓	G0334A	40G LR4 1310 nm QSFP+	QSFP+																																											
✓	✓	✓	G0366A	100G SR4 850 nm QSFP28	QSFP28																																											
✓	✓	✓	G0364A	100G LR4 1310 nm QSFP28	QSFP28																																											
✓	✓	✓	G0365A	100G LR4 Dual Rate 1310 nm QSFP28	QSFP28																																											
✓			G0402A	QSFP-DD 400GBASE-DR4	QSFP-DD																																											
✓			G0411A	QSFP-DD 400GBASE-FR4	QSFP-DD																																											
✓			G0412A	QSFP-DD 400GBASE-LR4	QSFP-DD																																											
✓			G0405A	OSFP 400GBASE-DR4	OSFP																																											
✓			G0406A	OSFP 400GBASE-FR4	OSFP																																											

Optical Transceivers Specification

Model/Order No.	Description (Approx. Distance)	Max. Input Power	Input Sensitivity	Input Wavelength	Output Power	Output Wavelength	Loop Back
G0332A 100M FX 1310 nm MM SFP	100BASE - FX 1310 nm multi mode (2 km)	-14 dBm	-31 dBm	1270 nm to 1600 nm	-20 to -15 dBm	1280 nm to 1380 nm	OK
G0319A Up to 2.7G 1310 nm 15 km SFP	STM-1/4/16 short haul 1310 nm single mode (15 km)	0 dBm	-18 dBm	1270 nm to 1580 nm	-5 to 0 dBm	1260 nm to 1360 nm	OK
G0320A Up to 2.7G 1310 nm 40 km SFP	STM-1/4/16 long haul 1310 nm single mode (40 km)	-9 dBm	-27 dBm	1270 nm to 1580 nm	-2 to +3 dBm	1280 nm to 1335 nm	>12 dB ATT
G0321A Up to 2.7G 1550 nm 80 km SFP	STM-1/4/16 long haul 1550 nm single mode (80 km)	-9 dBm	-28 dBm	1270 nm to 1580 nm	-2 to +3 dBm	1500 nm to 1580 nm	>12 dB ATT
G0328A 1G/2G/4G FC 850 nm SFP	1GFC, 2GFC, 4GFC 850 nm multi mode (0.5 km)	-3 dBm	-15 dBm	830 nm to 860 nm	-9 to 0 dBm	830 nm to 860 nm	>3 dB ATT
G0322A 1G/2G/4G FC 1310 nm SFP	1GFC, 2GFC, 4GFC 1310 nm single mode (10 km)	-3 dBm	-18 dBm	1260 nm to 1360 nm	-8 to 0 dBm	1260 nm to 1360 nm	>3 dB ATT
G0323A 1G/2G/4G FC 1550 nm SFP	1GFC, 2GFC, 4GFC 1550 nm single mode (40 km)	-3 dBm	-18 dBm	1470 nm to 1600 nm	0 to +5 dBm	1510 nm to 1590 nm	>8 dB ATT
G0315A 10G LR/LW 1310 nm SFP+	10GBASE - LR 1310 nm single mode (10 km)	+0.5 dBm	-14.4 dBm	1260 nm to 1565 nm	-6 to -1 dBm	1290 nm to 1330 nm	OK
G0316A 10G ER/EW 1550 nm 40 km SFP+	10GBASE - ER 1550 nm single mode (40 km)	-1 dBm	-15.8 dBm	1260 nm to 1565 nm	-3 to +3 dBm	1530 nm to 1560 nm	>4 dB ATT
G0318A 10G ZR/ZW 1550 nm 80 km SFP+	10GBASE - ER 1550 nm single mode (80 km)	-8 dBm	-22 dBm	1260 nm to 1565 nm	0 to +5 dBm	1525 nm to 1565 nm	>13 dB ATT
G0329A 10G LR 1310 nm SFP+	10GBASE - LR 1310 nm single mode (10 km)	+0.5 dBm	-14 dBm	1260 nm to 1355 nm	-8.2 to +0.5 dBm	1260 nm to 1355 nm	OK
G0356A 8G FC/10G SR 850 nm SFP+	8GFC, 10GBASE - SR 850 nm multi mode (0.3 km)	-1 dBm	-11.1 dBm	840 nm to 860 nm	-7.3 to -1 dBm	840 nm to 860 nm	OK
G0386A 16GFC SR 850 nm SFP+	16GFC 850 nm multi mode (0.035 km)	0 dBm	-10.5 dBm	840 nm to 860 nm	-7.5 dBm to	840 nm to 860 nm	OK
G0387A 16GFC LR 1310 nm SFP+	16GFC 1310 nm single mode (10 km)	+2 dBm	-12 dBm	1295 nm to 1325 nm	-5 to +2 dBm	1295 nm to 1325 nm	OK
G0388A 25G SR 850 nm SFP28	25GBASE - SR 850 nm multi mode (0.1 km)	+2.4 dBm	-10.3 dBm	840 nm to 860 nm	-8.4 to +2.4 dBm	840 nm to 860 nm	OK
G0389A 25G LR 1310 nm SFP28	25GBASE - LR 1310 nm single mode (0.1 km)	+2 dBm	-13.3 dBm	1260 nm to 1350 nm	-7 to +2 dBm	1295 nm to 1325 nm	OK
G0359A 40G SR4 850 nm QSFP+	40GBASE - SR4 850 nm multi mode (0.1 km)	+2.4 dBm (per Lane)	-9.9 dBm	840 nm to 860 nm	-8 to +2.4 dBm	840 nm to 860 nm	OK
G0334A 40G LR4 1310 nm QSFP+	40G Ethernet/OTN 1310 nm single mode (10 km)	+2.3 dBm (per Lane)	-11.5 dBm (per Lane)	1264.5 nm to 1277.5 nm 1284.5 nm to 1297.5 nm 1304.5 nm to 1317.5 nm 1324.5 nm to 1337.5 nm	+8.3 dBm (max.) (Total) -2 to +2.3 dBm (per Lane)	1264.5 nm to 1277.5 nm 1284.5 nm to 1297.5 nm 1304.5 nm to 1317.5 nm 1324.5 nm to 1337.5 nm	OK
G0366A 100G SR4 850 nm QSFP28	100G Ethernet 850 nm multi mode (0.1 km)	+2.4 dBm (per Lane)	-9.9 dBm (per Lane)	840 nm to 860 nm	+8.9 dBm (max.) (Total) -9.1 to +2.4 dBm (per Lane)	840 nm to 860 nm	OK
G0364A 100G LR4 1310 nm QSFP28	100G Ethernet 1310 nm single mode (10 km)	+4.5 dBm (per Lane)	-8.6 dBm (per Lane)	1294.53 nm to 1296.59 nm 1299.02 nm to 1301.09 nm 1303.54 nm to 1305.63 nm 1308.09 nm to 1310.19 nm	+10.5 dBm (max.) (Total) -4.3 to +4.5 dBm (per Lane)	1294.53 nm to 1296.59 nm 1299.02 nm to 1301.09 nm 1303.54 nm to 1305.63 nm 1308.09 nm to 1310.19 nm	OK
G0365A 100G LR4 Dual Rate 1310 nm QSFP28	100G Ethernet/OTN 1310 nm single mode (10 km)	+4 dBm (per Lane)	-8.4 dBm (per Lane)	1294.53 nm to 1296.59 nm 1299.02 nm to 1301.09 nm 1303.54 nm to 1305.63 nm 1308.09 nm to 1310.19 nm	+10 dBm (max.) (Total) -0.6 to +4 dBm (per Lane)	1294.53 nm to 1296.59 nm 1299.02 nm to 1301.09 nm 1303.54 nm to 1305.63 nm 1308.09 nm to 1310.19 nm	OK
G0402A QSFP-DD 400GBASE-DR4	400G Ethernet 1310 nm single mode (0.5 km)	+4.2 dBm (per Lane)	-4.4 dBm (per Lane)	1304.5 nm to 1317.5 nm	-0.8 to +4.2 dBm (per Lane)	1304.5 nm to 1317.5 nm	OK
G0411A QSFP-DD 400GBASE-FR4	400G Ethernet 1310 nm single mode (2 km)	+3.5 dBm (per Lane)	-4.6 dBm (per Lane)	1264.5 nm to 1277.5 nm 1284.5 nm to 1297.5 nm 1304.5 nm to 1317.5 nm 1324.5 nm to 1337.5 nm	+9.3 dBm (max.) (Total) -3.3 to +3.5 dBm (per Lane)	1264.5 nm to 1277.5 nm 1284.5 nm to 1297.5 nm 1304.5 nm to 1317.5 nm 1324.5 nm to 1337.5 nm	OK
G0412A QSFP-DD 400GBASE-LR4	400G Ethernet 1310 nm single mode (10 km)	+4.2 dBm (per Lane)	-6.6 dBm (per Lane)	1264.5 nm to 1277.5 nm 1284.5 nm to 1297.5 nm 1304.5 nm to 1317.5 nm 1324.5 nm to 1337.5 nm	+10.0 dBm (max.) (Total) -2.8 to +4.0 dBm (per Lane)	1264.5 nm to 1277.5 nm 1284.5 nm to 1297.5 nm 1304.5 nm to 1317.5 nm 1324.5 nm to 1337.5 nm	OK
G0405A OSFP 400GBASE-DR4	400G Ethernet 1310 nm single mode (0.5 km)	+4.2 dBm (per Lane)	-4.4 dBm (per Lane)	1304.5 nm to 1317.5 nm	-2.9 to +4.0 dBm (per Lane)	1304.5 nm to 1317.5 nm	OK
G0406A OSFP 400GBASE-FR4	400G Ethernet 1310 nm single mode (2 km)	+3.5 dBm (per Lane)	-5.0 dBm (per Lane)	1264.5 nm to 1277.5 nm 1284.5 nm to 1297.5 nm 1304.5 nm to 1317.5 nm 1324.5 nm to 1337.5 nm	+9.3 dBm (max.) (Total) -3.3 to +3.5 dBm (per Lane)	1264.5 nm to 1277.5 nm 1284.5 nm to 1297.5 nm 1304.5 nm to 1317.5 nm 1324.5 nm to 1337.5 nm	OK

Ordering Information

Network Master Pro MT1040A

Please specify the model/order number, name and quantity when ordering.
The names listed in the chart below are Order Names. The actual name of the item may differ from the Order Name.

MT1040A Main Unit

Model/Order No.	Name
MT1040A	Network Master Pro
Standard Accessories	
	Line Cord*1: 1 pc
B0745A	Softcase: 1 pc
B0771A*2	MT1040A Rear Panel kit: 1 pc
G0409A	AC Adaptor: 1 pc
G0413A	Li-ion Battery: 2 pcs
W4039AE	Quick Reference Guide: 1 pc
Z1746A	Stylus: 1 pc
Z2077A	Utilities ROM: 1 pc
Z2082A	Handle: 1 pc

Software Option*3

Model/Order No.	Name
MT1040A-003*4	Connectivity for WLAN/Bluetooth
MT1040A-011	Site Over Remote Access Connect

Optional Accessories

Model/Order No.	Name
B0720A	Rear Panel
B0730A	Screw 2U
B0731A	Screw 3U
B0733A	Hard Case
B0740A	Screw 4U
B0741A	Screw 5U
B0769A*5	MT1040A Screw Kit
G0306B*6	Video Inspection Probe
G0324A	Battery Charger
G0325A	GPS Receiver
G0382A*6	Autofocus Video Inspection Probe
Z1821A*7	Utilities in USB Stick

*1: One line cord is attached to the area to shipment.

*2: Composed of B0720A, B0730A, B0731A, B740A and B0741A.

*3: These options can be retrofitted.

The Model/Order No. of retrofit options is "-3**".

Example

MT1040A-003 Connectivity for WLAN/Bluetooth becomes MT1040A-303 Connectivity for WLAN/Bluetooth Retrofit.

When retrofitting an option, please either specify one of the following media along with the relevant option, or Web download.

Z1849A: DVD-ROM for Retrofit Options

Z1850A: USB Stick for Retrofit Options

*4: Available for certified countries and regions including USA, Japan and EU countries. Please visit the Anritsu web site for updated information.

*5: Composed of B0730A, B0731A, B740A and B0741A.

*6: This fiberscope uses the VIP function in the MT1040A Utility menu.

Different tip types are used by the G0382A and G0306B.



G0382A



G0306B

*7: Include MT1040A Operation Manual and the Remote Script Manual.

Model/Order No.	Name
Operation Manual (paper)	
W4038AE	MT1040A Transport Module Operation Manual
Optical Transceiver	
G0332A	100M FX 1310 nm MM SFP
G0319A	Up to 2.7G 1310 nm 15 km SFP
G0320A	Up to 2.7G 1310 nm 40 km SFP
G0321A	Up to 2.7G 1550 nm 80 km SFP
G0328A	1G/2G/4G FC 850 nm SFP
G0322A	1G/2G/4G FC 1310 nm SFP
G0323A	1G/2G/4G FC 1550 nm SFP
G0315A	10G LR/LW 1310 nm SFP+
G0316A	10G ER/EW 1550 nm 40 km SFP+
G0318A	10G ZR/ZW 1550 nm 80 km SFP+
G0329A	10G LR 1310 nm SFP+
G0356A	8G FC/10G SR 850 nm SFP+
G0386A	16GFC SR 850 nm SFP+
G0387A	16GFC LR 1310 nm SFP+
G0388A	25G SR 850 nm SFP28
G0389A	25G LR 1310 nm SFP28
G0359A	40G SR4 850 nm QSFP+
G0334A	40G LR4 1310 nm QSFP+
G0366A	100G SR4 850 nm QSFP28
G0364A	100G LR4 1310 nm QSFP28
G0365A	100G LR4 Dual Rate 1310 nm QSFP28
G0402A	QSFP-DD 400GBASE-DR4
G0411A	QSFP-DD 400GBASE-FR4
G0412A	QSFP-DD 400GBASE-LR4
G0405A	OSFP 400GBASE-DR4
G0406A	OSFP 400GBASE-FR4
Cable	
J1571A	Optical Cable SM LC/PC-SC/PC 3 m
J1575A	Optical Cable SM LC/PC-FC/PC 3 m
J1579A	Optical Cable SM LC/PC-LC/PC 3 m
J1581A	Optical Cable MM LC/PC-LC/PC 3 m
J1583A	Optical Attenuator 10 dB LC/PC-LC/PC
J1584A	RJ45 Cable 3 m

Maintenance Service*

Model/Order No.	Name
MT1040A-ES210	2 Years Extended Warranty Service
MT1040A-ES310	3 Years Extended Warranty Service
MT1040A-ES510	5 Years Extended Warranty Service

*: Available for new purchases only.

Ordering Information

Measurement Module

400G (QSFP-DD) Multirate Module MU104014A

Model/Order No.	Name
MU104014A	400G (QSFP-DD) Multirate Module
Standard Accessories	
B0768A*1	ESD Box: 1 pc
W4039AE*2	Transport Module Quick Reference Guide: 1 pc

Maintenance Service*3

Model/Order No.	Name
MU104014A-ES210	2 Years Extended Warranty Service
MU104014A-ES310	3 Years Extended Warranty Service
MU104014A-ES510	5 Years Extended Warranty Service

*1: The following combination of module patterns can be installed.

	QSFP-DD/QSFP28/QSFP+	SFP28/SFP+/SFP
Pattern 1	4	0
Pattern 2	3	2
Pattern 3	2	4
Pattern 4	1	6

*2: Accessory only when purchasing MU104014A main unit.

*3: Available for new purchases only.

*4: These options can be retrofitted.

The Model/Order No. of retrofit options is "-3**".

Example

MU104014A-020 TCP Throughput becomes MU104014A-320 TCP Throughput Retrofit.

When retrofitting an option, please either specify one of the following media along with the relevant option, or Web download.

Z1849A: DVD-ROM for Retrofit Options

Z1850A: USB Stick for Retrofit Options

*5: Requires to MU104014A-012.

*6: Requires that at least one of the following option is installed:

MU104014A-052, MU104014A-053, MU104014A-054, MU104014A-055, MU104014A-056

*7: MU104014A does not have a physical interface of the option.

The option is required for client signal mapped in the OTN.

Protocol Options*4

Model/Order No.	Name
Ethernet/eCPRI/RoE	
MU104014A-012	Ethernet up to 25G Dual Channel
MU104014A-013	Ethernet 40G Single Channel
MU104014A-014	Ethernet 40G Dual Channel
MU104014A-015	Ethernet 100G Single Channel
MU104014A-016	Ethernet 100G Dual Channel
MU104014A-020*5	TCP Throughput
MU104014A-033	Ethernet 400G Single Channel
OTN	
MU104014A-052	OTN up to 10G Dual Channel
MU104014A-053	OTN 40G Single Channel
MU104014A-054	OTN 40G Dual Channel
MU104014A-055	OTN 100G Single Channel
MU104014A-056	OTN 100G Dual Channel
MU104014A-063*6	ODU Multiplexing/Multi Stage
CPRI/OBSAI	
MU104014A-074	CPRI/OBSAI up to 25G Dual Channel
SDH/SONET	
MU104014A-082	SDH/SONET up to 10G Dual Channel
MU104014A-084*7	STM-256/OC-768 Client Signal
Fibre Channel	
MU104014A-092	FC up to 16G Dual Channel

Correspondence Ports by MU104014A Options

Standard (Bit Rate)	Interface	The Number of Correspondence Ports by MU104014A Options															
		012	013	014	015	016	033	052	053	054	055	056	074	082	092		
Ethernet	10/100/1000M	RJ45	2 Ports														
	100BASE-FX (125M)	SFP	2 Ports														
	1000BASE-X (1.250G)	SFP	2 Ports														
	10GBASE-XR (10.3125G)	SFP+	2 Ports														
	10GBASE-XW (9.953G)	SFP+	2 Ports														
	25GBASE-XX (25.781G)	SFP28	2 Ports														
	40GBASE-XX4 (41.250G)	QSFP+		1 Port	2 Ports												
100GBASE-XX4 (103.125G)	QSFP28				1 Port	2 Ports											
400GBASE-XX4 (425G)	QSFP-DD							1 Port									
OTN	OTU1 (2.666G)	SFP									2 Ports						
	OTU2 (10.709G)																
	OTU1e (11.049G)	SFP+									2 Ports						
	OTU2e (11.096G)	SFP+															
	OTU1f (11.270G)																
	OTU2f (11.318G)																
	OTU3 (43.018G)	QSFP+							1 Port	2 Ports							
OTU3e1 (44.571G)																	
OTU3e2 (44.583G)																	
OTU4 (111.810G)	QSFP28									1 Port	2 Ports						
Mobile X Haul	eCPRI/RoE 10/100/1000M	RJ45	2 Ports														
	eCPRI/RoE 1000BASE-x	SFP	2 Ports														
	eCPRI/RoE 10GBASE-xx	SFP+	2 Ports														
	eCPRI/RoE 25GBASE-xx	SFP28	2 Ports														
	eCPRI/RoE 40GBASE-xx	QSFP+		1 Port	2 Ports												
	eCPRI/RoE 100GBASE-xx	QSFP28				1 Port	2 Ports										
	CPRI1 (614.4M)																
	OBSAI 1x (768.0M)																
	CPRI2 (1228.8M)																
	OBSAI 2x (1536.0M)	SFP											2 Ports				
CPRI3 (2457.6M)																	
CPRI4 (3072.0M)																	
OBSAI 4x (3072.0M)																	
CPRI5 (4915.2M)																	
CPRI6 (6144.0M)																	
OBSAI 8x (6144.0M)	SFP+											2 Ports					
CPRI7 (9830.4M)																	
CPRI8 (10137.6M)																	
CPRI9 (12165.12M)																	
CPRI10 (24330.24M)	SFP28												2 Ports				
Fibre Channel	1GFC (1.063G)	SFP												2 Ports			
	2GFC (2.125G)																
	4GFC (4.250G)																
	8GFC (8.500G)	SFP+												2 Ports			
	10GFC (10.520G)																
16GFC (14.025G)																	
SDH/SONET	STM-1/OC-3 (155.52M)	SFP													2 Ports		
	STM-4/OC-12 (622.08M)																
	STM-64/OC-192 (9.953G)	SFP+													2 Ports		

Ordering Information

Measurement Module

400G (OSFP) Multirate Module MU104015A

Model/Order No.	Name
MU104015A	400G (OSFP) Multirate Module
Standard Accessories	
B0768A*1	ESD Box: 1 pc
W4039AE*2	Transport Module Quick Reference Guide: 1 pc

Maintenance Service*3

Model/Order No.	Name
MU104015A-ES210	2 Years Extended Warranty Service
MU104015A-ES310	3 Years Extended Warranty Service
MU104015A-ES510	5 Years Extended Warranty Service

*1: The following combination of module patterns can be installed.

	QSFP-DD/QSFP28/QSFP+	SFP28/SFP+/SFP	OSFP
Pattern 1	4	0	1
Pattern 2	3	2	1
Pattern 3	2	4	1
Pattern 4	1	6	1

*2: Accessory only when purchasing MU104015A main unit.

*3: Available for new purchases only.

*4: These options can be retrofitted.

The Model/Order No. of retrofit options is "-3**".

Example

MU104015A-020 TCP Throughput becomes MU104015A-320 TCP Throughput Retrofit.

When retrofitting an option, please either specify one of the following media along with the relevant option, or Web download.

Z1849A: DVD-ROM for Retrofit Options

Z1850A: USB Stick for Retrofit Options

*5: Requires to MU104015A-012.

*6: Requires that at least one of the following option is installed: MU104015A-052, MU104015A-053, MU104015A-055

*7: MU104015A does not have a physical interface of the option. The option is required for client signal mapped in the OTN.

Protocol Options*4

Model/Order No.	Name
Ethernet/eCPRI/RoE	
MU104015A-012	Ethernet up to 25G Dual Channel
MU104015A-013	Ethernet 40G Single Channel
MU104015A-015	Ethernet 100G Single Channel
MU104015A-020*5	TCP Throughput
MU104015A-033	Ethernet 400G Single Channel
OTN	
MU104015A-052	OTN up to 10G Dual Channel
MU104015A-053	OTN 40G Single Channel
MU104015A-055	OTN 100G Single Channel
MU104015A-063*6	ODU Multiplexing/Multi Stage
CPRI/OBSAI	
MU104015A-074	CPRI/OBSAI up to 25G Dual Channel
SDH/SONET	
MU104015A-082	SDH/SONET up to 10G Dual Channel
MU104015A-084*7	STM-256/OC-768 Client Signal
Fibre Channel	
MU104015A-092	FC up to 16G Dual Channel

Correspondence Ports by MU104015A Options

Standard (Bit Rate)	Interface	The Number of Correspondence Ports by MU104015A Options													
		012	013	015	033	052	053	055	074	082	092				
Ethernet	10/100/1000M	RJ45	2 Ports												
	100BASE-FX (125M)	SFP	2 Ports												
	1000BASE-X (1.250G)	SFP	2 Ports												
	10GBASE-XR (10.3125G)	SFP+	2 Ports												
	10GBASE-XW (9.953G)	SFP28	2 Ports												
	40GBASE-XX4 (41.250G)	QSFP+		1 Port											
	100GBASE-XX4 (103.125G)	QSFP28			1 Port										
OTN	400GBASE-XX4 (425G)	OSFP				1 Port									
	OTU1 (2.666G)	SFP					2 Ports								
	OTU2 (10.709G)	SFP+					2 Ports								
	OTU1e (11.049G)	SFP+					2 Ports								
	OTU2e (11.096G)	SFP+					2 Ports								
	OTU1f (11.270G)	SFP+					2 Ports								
	OTU2f (11.318G)	SFP+					2 Ports								
Mobile X Haul	OTU3 (43.018G)	QSFP+						1 Port							
	OTU3e1 (44.571G)	QSFP+						1 Port							
	OTU3e2 (44.583G)	QSFP+						1 Port							
	OTU4 (111.810G)	QSFP28							1 Port						
	eCPRI/RoE 10/100/1000M	RJ45	2 Ports												
	eCPRI/RoE 1000BASE-x	SFP	2 Ports												
	eCPRI/RoE 10GBASE-xx	SFP+	2 Ports												
	eCPRI/RoE 25GBASE-xxx	SFP28	2 Ports												
	eCPRI/RoE 40GBASE-xx	QSFP+		1 Port											
	eCPRI/RoE 100GBASE-xx	QSFP28			1 Port										
Fibre Channel	CPRI1 (614.4M)	SFP													
	OBSAI 1x (768.0M)	SFP													
	CPRI2 (1228.8M)	SFP													
	OBSAI 2x (1536.0M)	SFP													
	CPRI3 (2457.6M)	SFP													
	CPRI4 (3072.0M)	SFP													
	OBSAI 4x (3072.0M)	SFP													
	CPRI5 (4915.2M)	SFP													
	CPRI6 (6144.0M)	SFP+													
	OBSAI 8x (6144.0M)	SFP+													
SDH/SONET	CPRI7 (9830.4M)	SFP+													
	CPRI8 (10137.6M)	SFP+													
	CPRI9 (12165.12M)	SFP+													
	CPRI10 (24330.24M)	SFP28													
Fibre Channel	1GFC (1.063G)	SFP													
	2GFC (2.125G)	SFP													
	4GFC (4.250G)	SFP													
	8GFC (8.500G)	SFP+													
SDH/SONET	10GFC (10.520G)	SFP+													
	16GFC (14.025G)	SFP+													
	STM-1/OC-3 (155.52M)	SFP													2 Ports
SDH/SONET	STM-4/OC-12 (622.08M)	SFP													2 Ports
	STM-64/OC-192 (9.953G)	SFP+													2 Ports

Ordering Information

Measurement Module

100G Multirate Module MU104011A

Model/Order No.	Name
MU104011A	100G Multirate Module
Standard Accessories	
B0768A*1	ESD Box: 1 pc
W4039AE*2	Transport Module Quick Reference Guide: 1 pc

Maintenance Service*3

Model/Order No.	Name
MU104011A-ES210	2 Years Extended Warranty Service
MU104011A-ES310	3 Years Extended Warranty Service
MU104011A-ES510	5 Years Extended Warranty Service

*1: The following combination of module patterns can be installed.

	QSFP-DD/QSFP28/QSFP+	SFP28/SFP+/SFP
Pattern 1	4	0
Pattern 2	3	2
Pattern 3	2	4
Pattern 4	1	6

*2: Accessory only when purchasing MU104011A main unit.

*3: Available for new purchases only.

*4: These options can be retrofitted.

The Model/Order No. of retrofit options is "-3**".

Example

MU104011A-020 TCP Throughput becomes MU104011A-320 TCP Throughput Retrofit.

When retrofitting an option, please either specify one of the following media along with the relevant option, or Web download.

Z1849A: DVD-ROM for Retrofit Options

Z1850A: USB Stick for Retrofit Options

*5: Requires to MU104011A-012.

*6: Requires that at least one of the following option is installed:

MU104011A-052, MU104011A-053, MU104011A-054, MU104011A-055, MU104011A-056

*7: MU104011A does not have a physical interface of the option.

The option is required for client signal mapped in the OTN.

Protocol Options*4

Model/Order No.	Name
Ethernet/eCPRI/RoE	
MU104011A-012	Ethernet up to 25G Dual Channel
MU104011A-013	Ethernet 40G Single Channel
MU104011A-014	Ethernet 40G Dual Channel
MU104011A-015	Ethernet 100G Single Channel
MU104011A-016	Ethernet 100G Dual Channel
MU104011A-020*5	TCP Throughput
OTN	
MU104011A-052	OTN up to 10G Dual Channel
MU104011A-053	OTN 40G Single Channel
MU104011A-054	OTN 40G Dual Channel
MU104011A-055	OTN 100G Single Channel
MU104011A-056	OTN 100G Dual Channel
MU104011A-063*6	ODU Multiplexing/Multi Stage
CPRI/OBSAI	
MU104011A-074	CPRI/OBSAI up to 25G Dual Channel
SDH/SONET	
MU104011A-082	SDH/SONET up to 10G Dual Channel
MU104011A-084*7	STM-256/OC-768 Client Signal
Fibre Channel	
MU104011A-092	FC up to 16G Dual Channel

Correspondence Ports by MU104011A Options

Standard (Bit Rate)	Interface	The Number of Correspondence Ports by MU104011A Options														
		012	013	014	015	016	052	053	054	055	056	074	082	092		
Ethernet	10/100/1000M	RJ45	2 Ports													
	100BASE-FX (125M)	SFP	2 Ports													
	1000BASE-X (1.250G)	SFP+	2 Ports													
	10GBASE-XR (10.3125G)	SFP28	2 Ports													
	10GBASE-XW (9.953G)	QSFP+		1 Port	2 Ports											
	25GBASE-XX (25.781G)	QSFP28														
OTN	40GBASE-XX4 (41.250G)	SFP														
	100GBASE-XX4 (103.125G)	SFP+														
	OTU1 (2.666G)	SFP+								2 Ports						
	OTU2 (10.709G)															
	OTU1e (11.049G)															
	OTU2e (11.096G)										2 Ports					
Mobile X Haul	OTU1f (11.270G)	QSFP+									1 Port	2 Ports				
	OTU2f (11.318G)	QSFP28														
	OTU3 (43.018G)															
	OTU3e1 (44.571G)															
	OTU3e2 (44.583G)															
	OTU4 (111.810G)												1 Port	2 Ports		
	eCPRI/RoE 10/100/1000M	RJ45	2 Ports													
	eCPRI/RoE 1000BASE-x	SFP	2 Ports													
	eCPRI/RoE 10GBASE-xx	SFP+	2 Ports													
	eCPRI/RoE 25GBASE-xx	SFP28	2 Ports													
eCPRI/RoE 40GBASE-xx	QSFP+		1 Port	2 Ports												
Fibre Channel	eCPRI/RoE 100GBASE-xx	QSFP28														
	CPRI1 (614.4M)															
	OBSAI 1x (768.0M)															
	CPRI2 (1228.8M)															
	OBSAI 2x (1536.0M)															
	CPRI3 (2457.6M)															
	CPRI4 (3072.0M)															
	OBSAI 4x (3072.0M)															
	CPRI5 (4915.2M)															
	CPRI6 (6144.0M)															
OBSAI 8x (6144.0M)																
SDH/SONET	CPRI7 (9830.4M)	SFP+														
	CPRI8 (10137.6M)															
	CPRI9 (12165.12M)															
	CPRI10 (24330.24M)	SFP28														
Fibre Channel	1GFC (1.063G)	SFP														
	2GFC (2.125G)															
	4GFC (4.250G)															
	8GFC (8.500G)															
SDH/SONET	10GFC (10.520G)	SFP+														
	16GFC (14.025G)															
	STM-1/OC-3 (155.52M)	SFP														2 Ports
STM-4/OC-12 (622.08M)																
STM-64/OC-192 (9.953G)	SFP+															2 Ports

Ordering Information

Remote Software Service

The following licenses must be purchased to use the Site Over Remote Access MX109020A.

Mainframe Option License

Model/Order No.	Name
MT1040A-003*1	WLAN/Bluetooth Connect
MT1040A-011*2	Site Over Remote Access Connect

*1: Available for certified countries and regions including USA, Japan and EU countries. Please visit the Anritsu web site for updated information.

The Bluetooth® mark and logos are registered trademarks of Bluetooth SIG, Inc.

*2: Validity period is unlimited. An open TCP port may be required to allow the MT1040A to be connected from an in-company LAN to MX109020A, depending on the LAN security policy.

Subscription Option License

Model/Order No.	Name
MX109020A*3, *5, *6, *7	Site Over Remote Access Basic License
MX109020A-TL001*3, *4	Site Over Remote Access 1 Year License
MX109020A-001*5	Site Over Remote Access 8 Units
MX109020A-002*5	Site Over Remote Access Unlimited Units

*3: We recommend purchasing a 1-year license in addition to the basic license.

*4: When extending the usage period, we recommend purchasing in 1-year license periods

*5: Up to two measuring instruments can be remotely controlled simultaneously with the basic license.

This number can be increased to up to 8 units by purchasing the MX109020A-001 option, and up to 100 units by purchasing the MX109020A-002 option.

*6: You must agree to the service terms before purchasing SORA.

Refer to the service terms at the following URL: <https://www.anritsu.com/en-us/test-measurement/support/downloads/manuals/dwl20059>

*7: This product cannot be used in some regions and countries; please read the service terms for more details.